

FLUKE®

6100A

Electrical Power Standard

Users Manual

Table of Contents

Chapter	Title	Page
1	Introduction and Specifications.....	1-1
1-1.	Introduction	1-3
1-2.	Features.....	1-3
1-3.	About this manual.....	1-3
1-4.	How to use this Manual	1-4
1-5.	Contacting Fluke.....	1-4
1-6.	Specifications.....	1-5
1-7.	General Parametric Specifications	1-5
1-8.	Amplitude/Frequency Limits	1-6
1-9.	Open and Closed Loop operation.....	1-6
1-10.	Voltage Specifications.....	1-7
1-11.	Voltage Range Limits And Burden	1-7
1-12.	Voltage Sine Amplitude Specifications	1-7
1-13.	Voltage DC And Harmonic Amplitude Specifications	1-8
1-14.	Maximum Capacitive Loading For Output Stability.....	1-9
1-15.	Voltage Distortion And Noise.....	1-9
1-16.	Current Specifications	1-10
1-17.	Current Range Limits	1-10
1-18.	Load regulation specification ‘adder’	1-10
1-19.	Current Sine Amplitude Specifications	1-11
1-20.	Current DC And Harmonic Amplitude Specifications.....	1-12
1-21.	Current Distortion And Noise	1-13
1-22.	Maximum Inductive Loading For Output Stability.....	1-13
1-23.	Voltage From The Current Terminals	1-14
1-24.	Range Limits And Impedance’s.....	1-14
1-25.	Sine Specifications	1-14
1-26.	DC And Harmonic Amplitude Specifications.....	1-15
1-27.	Voltage From Current Terminals, Distortion And Noise.....	1-15
1-28.	Current To Voltage Phase Specifications.....	1-16
1-29.	Power Specifications	1-17
1-30.	Sinusoidal VA Specifications.....	1-17
1-31.	Sinusoidal Power Specifications	1-17
1-32.	16hz to 69hz, 1.0 > Power Factor > 0.75	1-17
1-33.	16Hz to 69Hz, 0.75 > Power Factor > 0.5.....	1-17
1-34.	16Hz to 69Hz, 0.5 > Power Factor > 0.25.....	1-18

1-35.	69Hz to 180Hz, 1.0 > Power Factor > 0.75.....	1-18
1-36.	69Hz to 180Hz, 0.75 > Power Factor > 0.5.....	1-18
1-37.	69Hz to 180Hz, 0.5 > Power Factor > 0.25.....	1-18
1-38.	180Hz to 450Hz, 1.0 > Power Factor > 0.75.....	1-19
1-39.	180Hz to 450Hz, 0.75 > Power Factor > 0.5.....	1-19
1-40.	180Hz to 450Hz, 0.5 > Power Factor > 0.25.....	1-19
1-41.	Power Factor < 0.25	1-19
1-42.	Reactive Power, Power Factor < 0.25	1-19
1-43.	Reactive Power, 0.25 > Power Factor > 0.5.....	1-19
1-44.	Reactive Power, 0.5 > Power Factor > 0.75.....	1-19
1-45.	Reactive Power, Power Factor > 0.75	1-20
1-46.	Reactive Power Calculation Methods	1-20
1-47.	Flicker Specifications.....	1-20
1-48.	Voltage and Current Flicker Specification.....	1-20
1-49.	Pst Indication Accuracy	1-21
1-50.	Fluctuating Harmonic Specifications	1-21
1-51.	Interharmonic Specifications.....	1-21
1-52.	Dip/Swell Specifications	1-22
1-53.	Multi-Phase Operation	1-22
1-54.	Voltage Channel To Voltage Channel Phase Specifications.....	1-22
1-55.	General Specifications.....	1-23
1-56.	Input Power	1-23
1-57.	Dimensions.....	1-23
1-58.	Environment.....	1-23
1-59.	Safety	1-23
1-60.	EMC.....	1-23
1-61.	Determining non-sinusoidal waveform amplitude specifications	1-24
1-62.	Non-sinusoidal voltage example.....	1-24
1-63.	Apparent power (S) accuracy calculations.....	1-25
1-64.	Apparent power example.....	1-25
1-65.	Power (P) accuracy calculations.....	1-27
1-66.	Power example.....	1-27
1-67.	References	1-29
2	Installation.....	2-1
2-1.	Introduction	2-3
2-2.	Unpacking and Inspection	2-3
2-3.	Reshipping the 6100A	2-3
2-4.	Placement and Rack Mounting.....	2-3
2-5.	Cooling Considerations	2-4
2-6.	Line Voltage	2-4
2-7.	Connecting to Line Power.....	2-4
2-8.	Connecting 6101A Auxiliary units.....	2-5
2-9.	Allocation of phases	2-5
3	Features.....	3-1
3-1.	Introduction	3-3
3-2.	Front Panel Features	3-3
3-3.	Windows™ User Interface	3-6
3-4.	The main graphical user interface areas.....	3-6
3-5.	Data entry from the front panel	3-7
3-6.	Data entry from an external keyboard and mouse.....	3-9
3-7.	Output channel selection	3-10
3-8.	Output control	3-10

3-9.	Rear Panel Features	3-11
4	Front Panel Operation.....	4-1
4-1.	Introduction	4-3
4-2.	Power up.....	4-3
4-3.	Warm up	4-3
4-4.	Basic Setup Procedures	4-4
4-5.	Global settings	4-5
4-6.	Frequency	4-5
4-7.	Line locking	4-5
4-8.	Harmonic edit mode.....	4-5
4-9.	Reactive power calculation	4-6
4-10.	Phase units.....	4-6
4-11.	Voltage output 4-wire or 2-wire connection	4-6
4-12.	More Settings	4-7
4-13.	Edit mode.....	4-7
4-14.	Direct Mode	4-7
4-15.	Deferred mode.....	4-7
4-16.	Changes that are not deferred.....	4-8
4-17.	Setting up voltage and current waveforms	4-8
4-18.	Harmonics, DC and Sine	4-9
4-19.	Definition	4-9
4-20.	Access to this function	4-9
4-21.	6100A Specification.....	4-9
4-22.	Sine/harmonic mode.....	4-9
4-23.	Setting up harmonics and DC.....	4-11
4-24.	Interharmonics.....	4-12
4-25.	Definition	4-12
4-26.	Access to this function	4-12
4-27.	6100A Specification.....	4-12
4-28.	Setting up Interharmonics	4-12
4-29.	Fluctuating harmonics	4-13
4-30.	Definition	4-13
4-31.	Access to this function	4-13
4-32.	6100A Specification.....	4-13
4-33.	Setting up Fluctuating Harmonics.....	4-14
4-34.	Dips and Swells	4-14
4-35.	Definition	4-14
4-36.	Access to this function	4-15
4-37.	6100A Specification.....	4-15
4-38.	Setting up Dips/swells.....	4-16
4-39.	Flicker.....	4-18
4-40.	Definition	4-18
4-41.	Access to this function	4-18
4-42.	6100A Specification.....	4-18
4-43.	Setting up Flicker	4-19
4-44.	Copy and Paste	4-19
4-45.	Copy	4-19
4-46.	Paste	4-19
5	Remote Operation.....	5-1
5-1.	Introduction	5-3
5-2.	Using the IEEE-488 Port for Remote Control.....	5-3
5-3.	Programming Options.....	5-3

5-4.	Capability Codes.....	5-4
5-5.	Bus Addresses.....	5-5
5-6.	Default bus address	5-5
5-7.	Limited Access	5-5
5-8.	Interconnections.....	5-5
5-9.	Operation via the IEEE 488 Interface.....	5-6
5-10.	General	5-6
5-11.	Operating Conditions	5-6
5-12.	Programmed Transfer to Local Control (GTL or REN False)	5-6
5-13.	‘Device Clear’	5-7
5-14.	Levels of Reset	5-7
5-15.	Message Exchange	5-8
5-16.	IEEE 488.2 Model.....	5-8
5-17.	Instrument STATUS Subsystem	5-8
5-18.	Incoming Commands and Queries	5-9
5-19.	Instrument Functions and Facilities	5-9
5-20.	Outgoing Responses.....	5-9
5-21.	‘Query Error’	5-10
5-22.	Request Service (RQS).....	5-10
5-23.	Reasons for Requesting Service.....	5-10
5-24.	RQS in the IEEE 488.2 Model.....	5-10
5-25.	Retrieval of Device Status Information	5-10
5-26.	General	5-10
5-27.	IEEE 488 and SCPI Standard defined Features	5-11
5-28.	Status Summary Information and SRQ.....	5-12
5-29.	Event Register Conditions	5-12
5-30.	Access via the Application Program.....	5-12
5-31.	Instrument Status Reporting IEEE 488.2 Basics	5-13
5-32.	IEEE 488.2 Model.....	5-13
5-33.	Instrument Model Structure	5-13
5-34.	Status Byte Register	5-13
5-35.	Reading the Status Byte Register.....	5-14
5-36.	Service Request Enable Register	5-14
5-37.	Reading the Service Request Enable Register	5-14
5-38.	IEEE 488.2 defined Event Status Register.....	5-14
5-39.	Standard Event Status Enable Register.....	5-16
5-40.	Reading the Standard Event Enable Register	5-17
5-41.	The Error Queue	5-17
5-42.	Instrument Status Reporting — SCPI Elements	5-17
5-43.	General	5-17
5-44.	SCPI Status Registers.....	5-17
5-45.	Reportable SCPI States	5-17
5-46.	SCPI Programming Language	5-18
5-47.	SCPI Commands and Syntax.....	5-19
5-48.	SCPI Command Summary	5-19
5-49.	Calibration Subsystem Command Details.....	5-25
5-50.	Output Subsystem Command Details.....	5-27
5-51.	Source Subsystem Command Details.....	5-28
5-52.	General Commands.....	5-28
5-53.	Power Values	5-29
5-54.	Voltage Setup.....	5-31
5-55.	DC and Harmonics Phenomenon.....	5-31
5-56.	Fluctuating Harmonics Phenomenon	5-33
5-57.	Interharmonics Phenomenon	5-34
5-58.	Dip Phenomenon.....	5-34

5-59.	Flicker Phenomenon	5-35
5-60.	Current Setup	5-36
5-61.	Harmonics Phenomenon	5-37
5-62.	Fluctuating Harmonics Phenomenon	5-39
5-63.	Interharmonics Phenomenon	5-40
5-64.	Dip Phenomenon.....	5-40
5-65.	Flicker Phenomenon	5-41
5-66.	Status Subsystem Command Details	5-42
5-67.	System Subsystem Command Details	5-43
5-68.	Unit Subsystem Command Details	5-44
5-69.	Common Commands and Queries	5-46
5-70.	Clear Status	5-46
5-71.	Event Status Enable.....	5-46
5-72.	Recall Event Status Enable	5-46
5-73.	Read Event Status Register	5-47
5-74.	*IDN? (Instrument Identification)	5-47
5-75.	Operation Complete	5-48
5-76.	Operation Complete?.....	5-48
5-77.	Recall the instrument Hardware Fitment.....	5-49
5-78.	Power On Status Clear	5-49
5-79.	Recall Power On Status Clear Flag	5-50
5-80.	Reset	5-51
5-81.	Service Request Enable.....	5-51
5-82.	Recall Service Request Enable.....	5-52
5-83.	Read Service Request Register.....	5-52
5-84.	Test Operations — Full Selftest	5-53
5-85.	Wait	5-53
5-86.	Device settings after *RST	5-54
5-87.	Introduction	5-54
5-88.	Device Settings at POWER ON	5-55
5-89.	General	5-55
5-90.	Power On Settings Related to Common IEEE 488.2 Commands	5-56
5-91.	*RST Settings Related to Common IEEE 488.2 Commands.....	5-57
5-92.	*RST Settings Related to SCPI Commands	5-58
5-93.	Worked examples	5-60
6	Operator Maintenance	6-1
6-1.	Introduction	6-3
6-2.	Confidence Test.....	6-3
6-3.	Setting up and running the Confidence Test	6-3
6-4.	Changing the user password	6-4
6-5.	Accessing the Fuse	6-4
6-6.	Cleaning the Air Filter	6-6
6-7.	Lithium Battery Replacement.....	6-8
7	Calibration	7-1
7-1.	Calibration methods.....	7-3
7-2.	Amplitude measurements.....	7-3
7-3.	Phase measurement	7-3
7-4.	The effect of phase uncertainty on power accuracy	7-3
7-5.	Calibration uncertainties for full accuracy	7-4
7-6.	Voltage amplitude calibration uncertainty required	7-4
7-7.	Current amplitude calibration uncertainty required	7-4
7-8.	Phase calibration uncertainty required	7-4

7-9.	Equipment required	7-5
7-10.	Overview of 6100A signal generation.....	7-6
7-11.	Independence of 6100A and 6101A.....	7-6
7-12.	The Fluke service center calibration system.....	7-8
7-13.	Characteristics of the calibration system.....	7-10
7-14.	Transducers.....	7-10
7-15.	DMM amplitude error contributions.....	7-10
7-16.	DMM amplitude phase contributions	7-10
7-17.	Voltage to voltage phase uncertainty	7-11
7-18.	Current to voltage phase uncertainty	7-11
7-19.	Overview of adjustment.....	7-12
7-20.	Calibration adjustment process.....	7-12
7-21.	Entering calibration mode	7-12
7-22.	Select instrument configuration	7-13
7-23.	Determine the 6100A/6101A error	7-14
7-24.	Initiate the adjustment.....	7-14
7-25.	Verification	7-14
7-26.	Calibration adjustment verification record	7-15
7-27.	Voltage adjustment points	7-15
7-28.	Current adjustment points	7-16
7-29.	Current adjustment points for 80A option (if fitted)	7-17
7-30.	Voltage from current terminals adjustment points	7-17
8	The 'Energy' Option	8-1
8-1.	Introduction	8-3
8-2.	Overview of functionality.....	8-3
8-3.	Principle of operation	8-3
8-4.	Limitations.....	8-3
8-5.	Energy specifications.....	8-4
8-6.	Pulse Inputs	8-4
8-7.	Pulse and Gate Inputs.....	8-4
8-8.	Pulse Output	8-4
8-9.	Gate Output	8-4
8-10.	Accuracy	8-4
8-11.	Test Duration.....	8-4
8-12.	Preparing to use the energy option	8-5
8-13.	Input channel configuration and meter constants	8-6
8-14.	Connect MUT and reference meters	8-6
8-15.	'Type' of energy.....	8-6
8-16.	Internal Pull-ups	8-6
8-17.	Energy Pulse Output meter constant and pull-up	8-7
8-18.	Conduct the test.....	8-7
8-19.	Test modes.....	8-7
8-20.	Free Run mode	8-8
8-21.	Counted/Timed mode	8-8
8-22.	Gated mode	8-9
8-23.	Packet mode	8-9
8-24.	Remote operation of the Energy option.....	8-10
8-25.	SCPI command set.....	8-10
8-26.	Operating mode	8-10
8-27.	Energy units	8-10
8-28.	Result presentation	8-11
8-29.	Results	8-11
8-30.	Output gating.....	8-11

8-31.	Input gating	8-12
8-32.	Warm-up sequence tree.....	8-12
8-33.	Warm-up duration	8-13
8-34.	Warm-up pulse source.....	8-13
8-35.	Test sequence tree	8-13
8-36.	Test duration.....	8-13
8-37.	Test pulse source	8-13
8-38.	MUT tree	8-14
8-39.	MUT meter constant.....	8-14
8-40.	MUT source	8-14
8-41.	MUT pull-up	8-14
8-42.	Reference tree.....	8-15
8-43.	Reference meter constant	8-15
8-44.	Reference source	8-15
8-45.	Reference pull-up	8-15
8-46.	Output tree.....	8-15
8-47.	Output meter constant	8-15
8-48.	Output pull-up	8-16
8-49.	Status subsystem	8-16
8-50.	Status operational Tree.....	8-16
8-51.	Operation event	8-16
8-52.	Operational enable.....	8-16
8-53.	Operation condition.....	8-17
8-54.	Energy Command Summary	8-17
8-55.	Action on receiving *RST.....	8-18
8-56.	Calibration of the Energy option	8-20
8-57.	By direct measurement with a frequency meter:.....	8-20
8-58.	Using an external reference frequency:.....	8-20

Appendices

A	Glossary	A-1
---	----------------	-----

List of Tables

Table	Title	Page
3-1.	Front Panel Features	3-4
3-2.	Rear Panel Features.....	3-12
7-1.	The contribution of phase uncertainty to power accuracy	7-4
7-2.	Calibration methods	7-5
7-3.	Samples per cycle	7-10
7-4.	DMM phase error uncertainty (degrees).....	7-11

List of Figures

Figure	Title	Page
3-1.	6100A Front Panel	3-3
3-2.	Graphical user interface	3-6
3-3.	Direct Mode key	3-7
3-3.	Output Menu frame	3-10
3-4.	The Output Menu	3-10
3-5.	Output Menu softkeys	3-10
3-6.	Rear Panel Features.....	3-11
3-7.	Rear Panel Connections	3-13
4-1.	Main Setup Page	4-4
4-2.	Global menu Softkeys.....	4-5
4-3.	Frequency, Line Locking	4-5
4-4.	Reactive power calculation	4-6
4-5.	Global Settings Menu	4-6
4-6.	4-wire/2-wire selection	4-6
4-7.	Channel selection	4-8
4-8.	Waveform top level.....	4-8
4-9.	Harmonics with time domain graph.....	4-10
4-10.	Harmonics with frequency domain graph.....	4-10
4-11.	Softkeys for Harmonics top level.....	4-11
4-12.	Softkeys for Harmonics second level.....	4-11
4-13.	Waveform Menu Menu for Interharmonics	4-12
4-14.	Softkeys for Interharmonics.....	4-12
4-15.	Waveform Menu for Fluctuating Harmonics	4-13
4-16.	Softkeys for Fluctuating Harmonics	4-14
4-17.	Waveshape Softkeys	4-14
4-18.	Waveform Menu for Dip.....	4-15
4-19.	Top level Dip Softkeys	4-16
4-20.	Dip Waveshape Softkeys	4-16
4-21.	Dip Trigger Softkeys.....	4-16
4-22.	Flicker Menu	4-18
4-23.	Flicker Softkeys	4-19
5-1.	IEEE 488 Compatibility Codes.....	5-4
5-2.	IEEE 488 Message Exchange Model.....	5-8
5-3.	IEEE-488 and SCPI Standard Defined Features.....	5-11
5-4.	Clear Status	5-46

5-5.	Event Status Enable	5-46
5-6.	Event Status Enable Query	5-46
5-7.	Event Status Register Query	5-47
5-8.	Instrument Identification.....	5-47
5-9.	Operation Complete	5-48
5-10.	Operation Complete Query	5-48
5-11.	Option Query	5-49
5-12.	Power On Status Clear	5-49
5-13.	Power On Status Clear Query	5-50
5-14.	Reset.....	5-51
5-15.	Service Request Enable.....	5-51
5-16.	Service Request Enable Query.....	5-52
5-17.	Status Byte Query	5-52
5-18.	Test Query.....	5-53
5-19.	Wait.....	5-53
6-1.	Waveform menu top level softkeys	6-4
6-2.	Rear Panel Showing Fuse	6-5
6-3.	Air Filter Access	6-7
7-1.	Signal generation	7-7
7-2.	After phase adjustment.....	7-7
7-3.	Phase Measurement Connections.....	7-8
7-4.	Waveforms.....	7-9
7-5.	Waveform menu Softkeys.....	7-12
7-6.	Password Prompt	7-12
7-7.	Adjust Instrument Screen.....	7-13
8-1.	Waveform menu top level softkeys	8-5
8-2.	Energy mode	8-5
8-3.	Input channel configuration and meter constants.....	8-6
8-4.	Energy top level softkeys.....	8-7
8-5.	Counted/Timed Mode Configuration.....	8-8
8-6.	Gated Mode Configuration	8-9
8-7.	Packet Mode Configuration	8-9

LIMITED WARRANTY & LIMITATION OF LIABILITY

Each Fluke product is warranted to be free from defects in material and workmanship under normal use and service. The warranty period is one year and begins on the date of shipment. Parts, product repairs and services are warranted for 90 days. This warranty extends only to the original buyer or end-user customer of a Fluke authorized reseller, and does not apply to fuses, disposable batteries or to any product which, in Fluke's opinion, has been misused, altered, neglected or damaged by accident or abnormal conditions of operation or handling. Fluke warrants that software will operate substantially in accordance with its functional specifications for 90 days and that it has been properly recorded on non-defective media. Fluke does not warrant that software will be error free or operate without interruption.

Fluke authorized resellers shall extend this warranty on new and unused products to end-user customers only but have no authority to extend a greater or different warranty on behalf of Fluke. Warranty support is available if product is purchased through a Fluke authorized sales outlet or Buyer has paid the applicable international price. Fluke reserves the right to invoice Buyer for importation of costs of repair/replacement parts when product purchased in one country is submitted for repair in another country.

Fluke's warranty obligation is limited, at Fluke's option, to refund of the purchase price, free of charge repair, or replacement of a defective product which is returned to a Fluke authorized service center within the warranty period.

To obtain warranty service, contact your nearest Fluke authorized service center or send the product, with a description of the difficulty, postage and insurance prepaid (FOB Destination), to the nearest Fluke authorized service center. Fluke assumes no risk for damage in transit. Following warranty repair, the product will be returned to Buyer, transportation prepaid (FOB Destination). If Fluke determines that the failure was caused by misuse, alteration, accident or abnormal condition of operation or handling, Fluke will provide an estimate of repair costs and obtain authorization before commencing the work. Following repair, the product will be returned to the Buyer transportation prepaid and the Buyer will be billed for the repair and return transportation charges (FOB Shipping Point).

THIS WARRANTY IS BUYER'S SOLE AND EXCLUSIVE REMEDY AND IS IN LIEU OF ALL OTHER WARRANTIES, EXPRESS OR IMPLIED, INCLUDING BUT NOT LIMITED TO ANY IMPLIED WARRANTY OF MERCHANTABILITY OR FITNESS FOR A PARTICULAR PURPOSE. FLUKE SHALL NOT BE LIABLE FOR ANY SPECIAL, INDIRECT, INCIDENTAL OR CONSEQUENTIAL DAMAGES OR LOSSES, INCLUDING LOSS OF DATA, WHETHER ARISING FROM BREACH OF WARRANTY OR BASED ON CONTRACT, TORT, RELIANCE OR ANY OTHER THEORY.

Since some countries or states do not allow limitation of the term of an implied warranty, or exclusion or limitation of incidental or consequential damages, the limitations and exclusions of this warranty may not apply to every buyer. If any provision of this Warranty is held invalid or unenforceable by a court of competent jurisdiction, such holding will not affect the validity or enforceability of any other provision.

Fluke Corporation
P O Box 9090
Everett
WA 98206-9090
USA

Fluke Europe BV
P O Box 1186
5602 BD
Eindhoven
The Netherlands

Fluke Precision
Measurement Ltd
Hurricane way
Norwich
NR6 6JB
UK

Claims

Immediately upon arrival, purchaser shall check the packing container against the enclosed packing list and shall, within thirty (30) days of arrival, give Fluke notice of shortages or any nonconformity with the terms of the order. If purchaser fails to give notice, the delivery shall be deemed to conform with the terms of the order.

The purchaser assumes all risk of loss or damage to instruments upon delivery by Fluke to the carrier. If an instrument is damaged in transit, **PURCHASER MUST FILE ALL CLAIMS FOR DAMAGE WITH THE CARRIER** to obtain compensation. Upon request by purchaser, Fluke will submit an estimate of the cost to repair shipment damage.

Fluke will be happy to answer all questions to enhance the use of this instrument. Please address your requests or correspondence to: Fluke Precision Measurement Ltd, Hurricane way, Norwich, NR6 6JB, UK.

OPERATOR SAFETY SUMMARY

WARNING

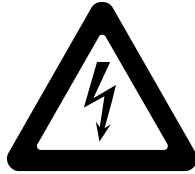

HIGH VOLTAGE

is used in the operation of this equipment

LETHAL VOLTAGE

may be present on the terminals, observe all safety precautions!

To avoid electrical shock hazard, the operator should not electrically contact the output hi or sense hi binding posts or any conductors connected to them, while the instrument is in both standby and operate modes. During operation, lethal voltages of up to 1430V Pk max may be present on these terminals.

General Safety Summary

This instrument has been designed and type tested in accordance with the following standard publications:

EN61010-1: 2001

UL61010A-1

CAN CSA 22.2 No 1010.1-92

and has been supplied in a safe condition.

This manual contains information and warnings that must be observed to keep the instrument in a safe condition and ensure safe operation. Operation or service in conditions or in a manner other than specified could compromise safety. For the correct and safe use of this instrument, it is essential that both operating and service personnel follow generally accepted safety procedures in addition to the safety precautions specified.

To avoid injury or fire hazard, the instrument must not be switched on if it is damaged or suspected to be faulty. Do not operate the instrument in damp, wet, condensing, dusty, or explosive gas conditions.

Whenever it is likely that safety protection has been impaired, the instrument must be made inoperative and be secured against any unintended operation. Inform qualified maintenance or repair personnel. Safety protection is likely to be impaired if, for example, the instrument shows visible damage or fails to operate normally.

Explanation of safety-related symbols and terms



DANGER
Risk of Electric Shock

The product is marked with this symbol to indicate that hazardous voltage (>33Vrms or 46.7V Pk or 70V DC may be present)



Caution
Refer to accompanying documents

The product is marked with this symbol when it is necessary for the user to refer to the instruction manual

WARNING Warning statements identify conditions or practices that could result in injury or loss of life.

Caution Caution statements identify conditions or practices that could result in damage to this or other property.

Protective Earth (or Grounding)

Protection Class 1 - The instrument must be operated with a Protective Earth/Ground connection via the Protective Earth/Grounding conductor of the AC line supply cable. The Protective Earth/Ground connects before the AC line and neutral connections when the supply plug is inserted into the instrument's rear panel AC line supply socket. If the final connection to the AC line supply is made elsewhere, ensure that the Protective Earth/Ground connection is made before AC line and neutral.

If for any reason there is a possibility the protective earth/ground connection might not be made before the AC line and neutral connections, or the output terminals are connected to a potentially hazardous live circuit, the separate protective earth/ground connection stud on the rear panel of the instrument must be connected to a suitable Protective Earth/Ground.

⚠ WARNING

Any interruption of the protective ground conductor inside or outside the instrument is likely to make the instrument dangerous. Intentional interruption is prohibited.

The Power Cord and Power Supply Disconnection

The front panel power switch is a remote on/off switch and does not directly disconnect line power. The power supply disconnect device is the ON / OFF switch on the rear panel of the instrument. The ON / OFF switch should be readily accessible whilst the instrument is in operation. If this operating condition cannot be satisfied, it is essential that either the power cord plug or a separate power disconnecting device be readily reached and accessible to the operator. To avoid electric shock and fire hazard, ensure that the power cord is not damaged and is adequately rated against power supply network fusing. If the power plug is to be the accessible disconnecting device, the cord must not be longer than 3 meters.

Signal connection

To avoid electric shock hazard, signal connections to the instrument must be made after the Protective Earth/Ground connection is made and disconnected before the Protective Earth/Ground connection is removed; i.e. the AC line supply lead must be connected whenever signal leads are connected.

⚠ WARNING

To avoid injury or loss of life, do not connect or disconnect signal leads while they are connected, or suspected of being connected, to any hazardous voltage or current source.

⚠ WARNING

Safety protection is likely to be impaired if unauthorized signal connector leads are used. Do not use signal connector leads if they are damaged. Voltage and current signal connector leads are provided with each instrument but they must only be used for the correct purpose. The Current signal connector lead must never be connected to the 6100A/6101A voltage terminals.

Do Not Operate Without Covers

To avoid electric shock or fire hazard, the instrument must not be operated with covers removed. The covers protect the user from live parts and (unless otherwise stated) should be removed only by suitably qualified personnel for maintenance and repair purposes.

⚠ WARNING

Removing the covers may expose voltages in excess of 2kV pk; these voltages may be present for up to one minute after the instrument has been disconnected from the power source, or longer under fault conditions.

Safe Operating Conditions

The unit must be operated only within the manufacturer's specified operating conditions.

Examples of specification that must be considered are:

- For indoor use only
- Ambient temperature
- Ambient humidity
- Power supply voltage and frequency
- Maximum terminal voltages or currents
- Altitude
- Ambient pollution level
- Exposure to shock and vibration

To avoid electric shock or fire hazard, do not apply to or subject the instrument to any condition that is outside specified range. See section one of this manual for detailed specification of the instrument and its operating conditions.

⚠ Caution

Direct sunlight, radiators and other heat sources should be taken into account when assessing the ambient temperature.

Fuse Requirements

The 6100A and 6101A require a special fuse with rated current of 15A and rated breaking capacity of 750A. The fuse must be rated for a voltage of 250V AC.

To access the fuse and ensure the line power is disconnected and follow the procedure described in Chapter 6. The approved fuse is shown below

Fluke part number and description:	1998159	T15AH 250V 32mm
Fuse manufacturer and part number:	Bussmann	MDA-15

Measurement Category I

Measurement terminals are designed for connection at Measurement (Overvoltage) Category I. To avoid electric shock or fire hazard, do not connect the instrument's terminals directly to the AC line power supply or any other source of voltage or current that might temporarily exceed the peak ratings of the instrument.

Maintenance and Repair

Always observe local or national safety regulations and rules for the prevention of accidents and hazard while performing any work. Always disconnect the instrument from all signal sources and then the AC line power supply before removing any covers. Any adjustment, parts replacement, maintenance or repair should be carried out only by Fluke authorized technical personnel.

⚠ WARNING

For continued protection against injury and fire hazard it is essential that only manufacturer supplied parts be used to replace parts relevant to safety. Safety tests must be performed after the replacement of parts relevant to safety.

Ventilation and Dust

The instrument relies on forced air cooling via ventilation slots in the sides of the instrument. Adequate ventilation can usually be achieved by positioning on a level surface and by leaving a 100mm (4" gap) around the instrument. Care should be taken to avoid restricting the airflow at the sides of the instrument, as damage may result from overheating. The instrument is designed to IP4X and is specified for use in a Pollution Category II environment, which is normally non-conductive with temporary light condensation. Do not operate the instrument while condensation is present. Do not use the instrument in more hostile, dusty or wet conditions.

Cleaning

Ensure the instrument signal and then power leads are disconnected prior to cleaning. Use only a damp, lint-free cloth to clean fascia and case parts. See Chapter 6 for details of air filter cleaning.

Observe any additional safety warnings or instructions that appear in this manual.

Chapter 1

Introduction and Specifications

	Title	Page
1-1.	Introduction.....	1-3
1-2.	Features	1-3
1-3.	About this manual	1-3
1-4.	How to use this Manual.....	1-4
1-5.	Contacting Fluke	1-4
1-6.	Specifications.....	1-5
1-7.	General Parametric Specifications.....	1-5
1-8.	Amplitude/Frequency Limits	1-6
1-9.	Open and Closed Loop operation.....	1-6
1-10.	Voltage Specifications.....	1-7
1-11.	Voltage Range Limits And Burden	1-7
1-12.	Voltage Sine Amplitude Specifications.....	1-7
1-13.	Voltage DC And Harmonic Amplitude Specifications.....	1-8
1-14.	Maximum Capacitive Loading For Output Stability	1-9
1-15.	Voltage Distortion And Noise	1-9
1-16.	Current Specifications	1-10
1-17.	Current Range Limits	1-10
1-18.	Load regulation specification ‘adder’	1-10
1-19.	Current Sine Amplitude Specifications	1-11
1-20.	Current DC And Harmonic Amplitude Specifications	1-12
1-21.	Current Distortion And Noise	1-13
1-22.	Maximum Inductive Loading For Output Stability	1-13
1-23.	Voltage From The Current Terminals	1-14
1-24.	Range Limits And Impedance’s	1-14
1-25.	Sine Specifications	1-14
1-26.	DC And Harmonic Amplitude Specifications	1-15
1-27.	Voltage From Current Terminals, Distortion And Noise	1-15
1-28.	Current To Voltage Phase Specifications.....	1-16
1-29.	Power Specifications	1-17
1-30.	Sinusoidal VA Specifications.....	1-17
1-31.	Sinusoidal Power Specifications	1-17
1-32.	16hz to 69hz, 1.0 > Power Factor > 0.75	1-17
1-33.	16Hz to 69Hz, 0.75 > Power Factor > 0.5.....	1-17
1-34.	16Hz to 69Hz, 0.5 > Power Factor > 0.25.....	1-18

1-35.	69Hz to 180Hz, 1.0 > Power Factor > 0.75.....	1-18
1-36.	69Hz to 180Hz, 0.75 > Power Factor > 0.5.....	1-18
1-37.	69Hz to 180Hz, 0.5 > Power Factor > 0.25.....	1-18
1-38.	180Hz to 450Hz, 1.0 > Power Factor > 0.75.....	1-19
1-39.	180Hz to 450Hz, 0.75 > Power Factor > 0.5.....	1-19
1-40.	180Hz to 450Hz, 0.5 > Power Factor > 0.25.....	1-19
1-41.	Power Factor < 0.25	1-19
1-42.	Reactive Power, Power Factor < 0.25	1-19
1-43.	Reactive Power, 0.25 > Power Factor > 0.5.....	1-19
1-44.	Reactive Power, 0.5 > Power Factor > 0.75	1-19
1-45.	Reactive Power, Power Factor > 0.75	1-20
1-46.	Reactive Power Calculation Methods.....	1-20
1-47.	Flicker Specifications	1-20
1-48.	Voltage and Current Flicker Specification	1-20
1-49.	Pst Indication Accuracy.....	1-21
1-50.	Fluctuating Harmonic Specifications.....	1-21
1-51.	Interharmonic Specifications	1-21
1-52.	Dip/Swell Specifications	1-22
1-53.	Multi-Phase Operation	1-22
1-54.	Voltage Channel To Voltage Channel Phase Specifications	1-22
1-55.	General Specifications.....	1-23
1-56.	Input Power	1-23
1-57.	Dimensions.....	1-23
1-58.	Environment	1-23
1-59.	Safety	1-23
1-60.	EMC	1-23
1-61.	Determining non-sinusoidal waveform amplitude specifications	1-24
1-62.	Non-sinusoidal voltage example.....	1-24
1-63.	Apparent power (S) accuracy calculations	1-25
1-64.	Apparent power example.....	1-25
1-65.	Power (P) accuracy calculations.....	1-27
1-66.	Power example	1-27
1-67.	References	1-29

1-1. Introduction

The Fluke 6100A Electrical Power Standard is a precise instrument for the calibration of measuring devices used to determine the magnitude and quality of power supplied to consumers. With the 6100A instrument, you can synthesize irregular power supplies with phenomena of voltage harmonics, interharmonics, fluctuating harmonics, flicker, dips and swells.

The optional Fluke 6101A Auxiliary Power Standard extends the functionality to a second phase. It is possible to add additional phases as required to build up to a fully configured four phase (3 phase plus neutral) system.

Specifications are provided at the end of this chapter.

1-2. Features

Traceable Power Measurement

Configurable from 1 to 4 independent phases

Fully independent control of Voltage and Current on each phase

1kV and 21 Amps available (80A with option 6100A/80A) on each phase ('N' phase limited to 33V RMS)

Up to 100 harmonics at any one time

Fluctuating harmonics and interharmonics to IEC 61000-4-7

Flicker to IEC 61000-3-4 and 61000-4-15

Simultaneous Power Quality Phenomena to IEC61000-4-30 & IEEE P1159.1 (draft)

User definable test signals

User selectable reactive power calculation method

>13 V peak compliance on all current outputs

1-3. About this manual

This manual provides complete information for installing the Electrical Power Standard and operating it from the front panel and remotely. It also provides a glossary of terms as well as detailed specifications. The following topics are covered in this manual:

Installation

Operating controls and features

Front panel operation

Remote operation (IEEE-488.2)

Data transfer via floppy disk

Operator maintenance, including calibration

1-4. How to use this Manual

You should first read the safety section at the front of this manual.

Use the following list to find the location of specific information.

Instrument specifications: The end of this Chapter

Unpacking and setup: Chapter 2.

Installation and rack mounting: Chapter 2

AC line power and interface cabling: Chapter 2

Connecting 6101A Auxiliary Units: Chapter 2

Controls, indicators, and displays: Chapter 3

Basic setup procedure: Chapter 4

Front panel operation: Chapter 4

Output Voltage and Current connection: Chapter 4

Remote operation (IEEE-488.2): Chapter 5

Operator maintenance: Chapter 6

Calibration: Chapter 7

1-5. Contacting Fluke

To contact Fluke for product information, operating assistance, service, or to get the location of the nearest Fluke distributor or Service Center, call:

1-888-99FLUKE (1-888-993-5853) in U.S.A.

1-800-36-FLUKE (1-800-363-5853) in Canada

+31-402-678-200 in Europe

+81-3-3434-0181 Japan

+65-738-5655 Singapore

+1-425-446-5500 from other countries

Visit Fluke's web site at: www.fluke.com.

1-6. Specifications

The accuracy's stated include the calibration uncertainty provided by Fluke Service Centers. In the following specifications uncertainties are stated at coverage factor $k=2$, equivalent to 95% confidence level, in accordance with accepted metrology practices.

1-7. General Parametric Specifications

Voltage/Current amplitude setting resolution	6 digits
Range of fundamental frequencies	16 Hz to 850 Hz
Line frequency locking	45 Hz to 65.9 Hz at users discretion
Frequency accuracy	50 ppm
Frequency setting resolution	0.1 Hz
Warm up time to full accuracy	1 hour or twice the time since last warmed up
Settling time following change to the output	1.4 second [2]
Nominal angle between voltage phases	120°
Nominal angle between voltage and current of a phase	0°
Phase angle setting	$\pm 180^\circ, \pm \pi$ radians [1]
Phase angle setting resolution	0.001 °, 0.00001 radians [1]
Maximum number of voltage harmonics	100 including the 1 st (fundamental frequency)
Maximum number of current harmonics	100 including the 1 st (fundamental frequency)

[1] Switching between phase set in degrees, phase set in radians and back may not be consistent because of calculation rounding errors.

[2] Settling time (T_s) of 21A and 80A ranges depends on RMS output as a proportion of full range and can be calculated from: $T_s = \%FR^2 \times 80$ seconds

1-8. Amplitude/Frequency Limits

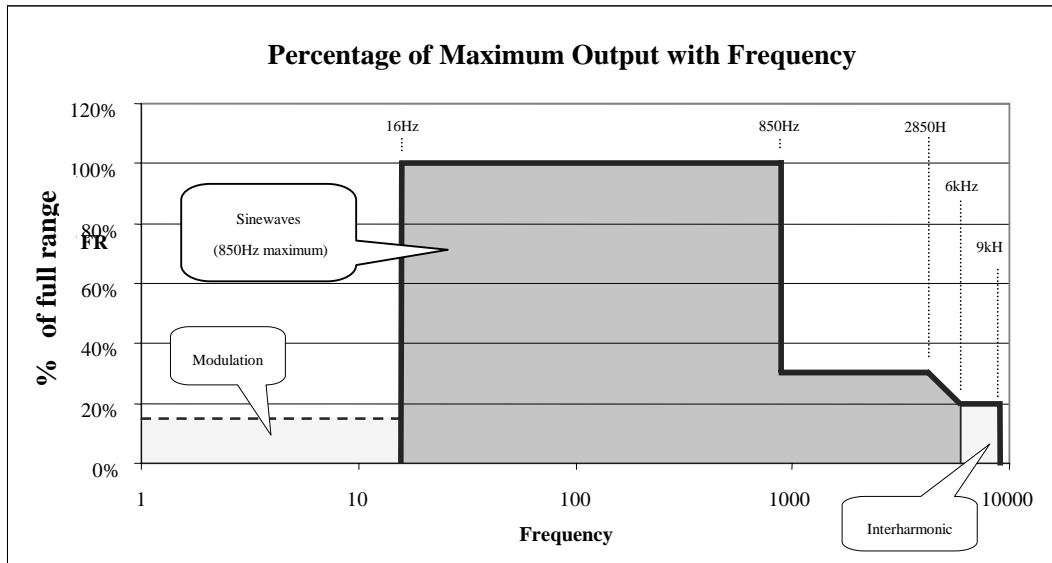

[1] If the option is fitted, the 80 Amp range minimum settable fundamental frequency is 40Hz and the maximum harmonic frequency is 3kHz.

[2] Although the minimum settable fundamental frequency is 16Hz, modulated waveforms may generate frequency components below that, including DC.

[3] A DC component of up to 50% of range may be added to all voltage and current ranges except 80A.

[4] If the bandwidth limit is enabled, maximum frequency is 3kHz (1.5kHz for the 80A range).

1-9. Open and Closed Loop operation

Full accuracy for pure sine or sine plus harmonics is achieved by using analogue and digital feedback systems (closed loop). When any of: Flicker, Fluctuating harmonics, Dip/Swell or Interharmonics are applied, the digital system is automatically uncoupled (open loop). Initial performance is as described in the 1-year accuracy column but performance degrades with time as described by the stability column. Full accuracy can be restored by momentarily disabling which ever of Flicker, Fluctuating harmonics, Dip/Swell or Interharmonics are enabled, or by changing the value of the sine wave or any harmonic for that channel.

1-10. Voltage Specifications

1-11. Voltage Range Limits And Burden

Full Range (FR)	16 V	33 V	78 V	168 V	336 V	1008 V
Max peak [1][2]	22.6 V	46.6 V	110 V	237 V	475 V	1425 V
Maximum Burden (peak current) [3]	1.13 A	1.13 A	707 mA	311 mA	141 mA	71 mA

[1] these values apply to sinusoidal, distorted and modulated wave-shapes.

[2] voltage harmonic phase angle significantly affects the peak value of a non-sinusoidal waveform.

[3] To achieve specifications in 4-wire sense, resistance in the sense lead must be less than 1Ω and resistance in the power leads less than 1.5Ω.

1-12. Voltage Sine Amplitude Specifications

Range	Frequency	Voltage [5]	1 year accuracy, tcal [4] ± 5°C ± (ppm of output + mV) [1][6]		'Closed loop' Stability ± (ppm of output + mV) per hour [2]		Open loop' Stability ± (ppm of output + mV) per hour [2][3]	
1.0 V to 16 V	16 Hz – 450 Hz	1.0 V – 6.4 V	122	1.0	40	0.8	200	0.8
		6.4 V – 16 V	112	1.0	40	0.4	200	0.8
	450 Hz – 850 Hz	1.0 V – 6.4 V	164	1.0	40	0.8	200	0.8
		6.4 V – 16 V	150	1.0	40	0.4	200	0.8
2.3 V to 33 V	16 Hz – 450 Hz	2.3 V – 13.2 V	122	2.0	40	0.8	200	0.8
		13.2 V – 33 V	112	1.5	40	0.6	200	0.8
	450 Hz – 850 Hz	2.3 V – 13.2 V	164	2.0	40	0.8	200	0.8
		13.2 V – 33 V	150	1.5	40	0.6	200	0.8
5.6 V to 78 V	16 Hz – 450 Hz	5.6 V – 31 V	122	2.0	40	0.8	200	0.8
		31 V – 78 V	112	2.0	40	0.6	200	0.8
	450 Hz – 850 Hz	5.6 V – 31 V	164	2.0	40	0.8	200	0.8
		31 V – 78 V	150	2.0	40	0.6	200	0.8
11V to 168 V	16 Hz – 450 Hz	11 V – 67 V	122	4.4	40	1.5	200	1.5
		67 V – 168 V	112	4.4	40	1.5	200	1.5
	450 Hz – 850 Hz	11 V – 67 V	164	4.4	40	1.5	200	0.8
		67 V – 168 V	150	4.4	40	1.5	200	0.8
23 V to 336 V	16 Hz – 450 Hz	23 V – 134 V	122	8.8	40	3.0	200	3.0
		134 V – 336 V	112	8.8	40	3.0	200	3.0
	450 Hz – 850 Hz	23 V – 134 V	164	8.8	40	3.0	200	0.8
		134 V – 336 V	150	8.8	40	3.0	200	0.8
70V to 1008 V	16 Hz – 450 Hz	70 V – 330 V	166	26	100	10	200	10
		330 V – 1008 V	158	26	100	10	200	10
	450 Hz – 850 Hz	70 V – 330 V	190	26	100	10	200	10
		330 V – 1008 V	175	26	100	10	200	10

[1] four wire sense only, for two wire operation, add an additional voltage = 0.3Ω x maximum burden current to the accuracy specification

[2] for $\pm 1^\circ\text{C}$ and constant load and connection conditions

[3] When Flicker, Fluctuating harmonics, Dip/Swell or Interharmonics are applied, 'Open loop' stability specification must be added to the 1-year accuracy specification as described in paragraph 1-9.

[4] tcal = temperature of last calibration.

[5] Output levels less than the range minimum can be set but are not specified.

[6] These specifications assume a 'sampling' measuring instrument. Some RMS sensing instruments have voltage input bandwidths of several MHz. The 6100A specification should be expanded by the non-harmonic noise floor in table 1-15 for RMS sensing devices.

1-13. Voltage DC And Harmonic Amplitude Specifications

Range	Output [4][5]	Frequency	1 year accuracy, tcal [6] $\pm 5^\circ\text{C}$ \pm (ppm of output + mV) [1]		'Closed loop' Stability \pm (ppm of output + mV) per hour [2]		Open loop' Stability \pm (ppm of output + mV) per hour [2][3]	
1.0 V to 16 V	0 V – 8 V	DC	122	5.0	40	1.8	200	1.8
	0 V – 4.8 V	16 Hz – 450 Hz	122	1.0	40	0.8	200	0.8
		450 Hz – 850 Hz	164	1.0	40	0.8	200	0.8
		850 Hz – 6 kHz	512	1.0	60	0.8	400	0.8
2.3 V to 33 V	0 V – 16.5 V	DC	122	10	40	3.3	200	3.3
	0 V – 9.9 V	16 Hz – 450 Hz	122	2.0	40	0.8	200	0.8
		450 Hz – 850 Hz	164	2.0	40	0.8	200	0.8
		850 Hz – 6 kHz	512	2.0	60	0.8	400	0.8
5.6 V to 78 V	0 V – 39 V	DC	122	24	40	8.0	200	8.0
	0 V – 23 V	16 Hz – 450 Hz	122	2.0	40	0.8	200	0.8
		450 Hz – 850 Hz	164	2.0	40	0.8	200	0.8
		850 Hz – 6 kHz	512	2.0	60	0.8	400	0.8
11V to 168 V	0 V – 84 V	DC	122	50	40	15	200	15
	0 V – 50 V	16 Hz – 450 Hz	122	4.4	40	1.5	200	1.5
		450 Hz – 850 Hz	164	4.4	40	1.5	200	1.5
		850 Hz – 6 kHz	512	4.4	60	1.5	400	1.5
23 V to 336 V	0 V – 168 V	DC	122	100	40	30	200	30
	0 V – 100 V	16 Hz – 450 Hz	122	12.0	40	3.0	200	3.0
		450 Hz – 850 Hz	164	12.0	40	3.0	200	3.0
		850 Hz – 6 kHz	512	12.0	60	3.0	400	3.0
70V to 1008 V	0 V – 504 V	DC	166	300	100	100	200	100
	0V – 302 V	16 Hz – 450 Hz	166	33	100	10	200	10
		450 Hz – 850 Hz	190	33	100	10	200	10
		850 Hz – 6 kHz	524	33	150	10	450	10

[1] four wire sense only, for two wire operation, add an additional voltage = $0.3\Omega \times$ maximum burden current to the accuracy specification

[2] for $\pm 1^\circ\text{C}$ and constant load and connection conditions

[3] When Flicker, Fluctuating harmonics, Dip/Swell or Interharmonics are applied, 'Open loop' stability specification must be added to the 1-year accuracy specification as described in paragraph 1-9

[4] These specifications are only applicable if the combined voltage RMS output is greater than the range minimum. If the combined output is below the range minimum the output is not specified.

[5] The maximum value for a single harmonic (2nd to 100th) below 2850 Hz is 30% of range. See paragraph 1-8 for profile above 2850 Hz.

[6] tcal = temperature of last calibration.

1-14. Maximum Capacitive Loading For Output Stability

The voltage output will remain stable with 100nF load but may not be able to drive that capacitance at all voltage/frequency/harmonic combinations due to burden current limitations.

1-15. Voltage Distortion And Noise

Full Range	Frequency	Maximum harmonic distortion [1]				Non-harmonic noise floor (relative to full range)	
		Either:				16Hz to 4MHz	
		the largest of	or the largest of			dB	%
		dB	Volts	% setting	% range		
16 V	16 Hz – 850 Hz	-76	480 uV	0.016	0.003	-66	0.05
	850 Hz – 6 kHz	-52	2.4 mV	0.25	0.015	-66	0.05
33 V	16 Hz – 850 Hz	-76	990 uV	0.016	0.003	-70	0.032
	850 Hz – 6 kHz	-52	5.0 mV	0.25	0.015	-70	0.032
78 V	16 Hz – 850 Hz	-76	2.3 mV	0.016	0.003	-72	0.025
	850 Hz – 6 kHz	-52	11 mV	0.25	0.015	-72	0.025
168 V	16 Hz – 850 Hz	-76	5.0 mV	0.016	0.003	-76	0.016
	850 Hz – 6 kHz	-52	25 mV	0.25	0.015	-76	0.016
336 V	16 Hz – 850 Hz	-76	10 mV	0.016	0.003	-66	0.05
	850 Hz – 6 kHz	-52	50 mV	0.25	0.015	-66	0.05
1008 V	16 Hz – 850 Hz	-76	30 mV	0.016	0.003	-60	0.10
	850 Hz – 6 kHz	-52	151 mV	0.25	0.015	-60	0.10

[1] dB harmonic distortion increases linearly between 850Hz and 6kHz

1-16. Current Specifications

Option 6100A/80A adds the 80A range to 6100A and 6101A. Without option 6100A/80A the maximum output current is 21A RMS.

1-17. Current Range Limits

Full Range (FR)	0.25 A	0.5 A	1 A	2 A	5 A	10 A	21 A	80 A
Max peak [1][2]	0.353 A	0.707 A	1.414 A	2.828 A	7.07 A	14.14 A	29.7 A	113 A
Maximum compliance voltage at FR (Vpk) [3]	14 V	14 V	14 V	14 V	14 V	14 V	12.5 V	2 V

[1] These values apply to sinusoidal, distorted and modulated wave-shapes.

[2] Current harmonic phase angle significantly affects the peak value of a non-sinusoidal waveform.

[3] Above 450Hz, the instrument will drive current outputs that develop maximum compliance voltage across the load, but an 'adder' to the accuracy specification in tables 1-20 and 1-21 may be required. Calculation of the 'adders' is described below.

1-18. Load regulation specification 'adder'

The finite output impedance of the current amplifier causes a 'load regulation' effect that must be taken into consideration. Let V_F = the peak voltage developed across the load due to current I_F at frequency F . Let I_{FR} be the maximum current and V_{max} the maximum compliance peak voltage for the range in use.

If $V_F/V_{max} \leq I_F/I_{FR}$ no specification adder is required. Otherwise, the adder is calculated:

$$\text{if } V_F/V_{max} > I_F/I_{FR}, \text{ add: } \frac{I_{FR} \times F \times V_F}{20 \times V_{max}} \mu A$$

Example: The output is a 800Hz, 0.5A RMS sinewave on the 5A range. The current specification from paragraph 1-19 is:

$$182 \text{ ppm} + 120 \mu A = 91 \mu A + 120 \mu A$$

The voltage across the output is 6V peak and maximum compliance is 14V, i.e., $V_F/V_{max} > I_F/I_{FR}$. The 'adder' is:

$$\frac{5 \times 800 \times 6}{20 \times 14} = 85 \mu A$$

The current specification becomes:

$$91 \mu A + 120 \mu A + 85 \mu A = 296 \mu A$$

1-19. Current Sine Amplitude Specifications

Range	Frequency	Current [4]	1 year accuracy, tcal [3] ± 5°C ± (ppm of output + μA) [5]		'Closed loop' Stability ± (ppm of output + μA) per hour [1]		Open loop' Stability ± (ppm of output + μA) per hour [1][2]	
0.01 A - 0.25 A	16 Hz – 450 Hz	0.01 A – 0.1 A	139	6	50	3	240	3
		0.1 A – 0.25 A	130	6	50	3	240	3
	450 Hz – 850 Hz	0.01 A – 0.1 A	182	6	50	3	360	3
		0.1 A – 0.25 A	170	6	50	3	360	3
0.05 A - 0.5 A	16 Hz – 450 Hz	0.05 A – 0.2 A	139	12	50	5	240	5
		0.2 A – 0.5 A	130	12	50	5	240	5
	450 Hz – 850 Hz	0.05 A – 0.2 A	182	12	50	5	360	5
		0.2 A – 0.5 A	170	12	50	5	360	5
0.1 A - 1 A	16 Hz – 450 Hz	0.1 A – 0.4 A	139	24	50	10	240	10
		0.4 A – 1 A	130	24	50	10	240	10
	450 Hz – 850 Hz	0.1 A – 0.4 A	182	24	50	10	360	10
		0.4 A – 1 A	170	24	50	10	360	10
0.2 A - 2 A	16 Hz – 450 Hz	0.2 A – 0.8 A	139	48	50	20	240	20
		0.8 A – 2 A	130	48	50	20	240	20
	450 Hz – 850 Hz	0.2 A – 0.8 A	182	48	50	20	360	20
		0.8 A – 2 A	170	48	50	20	360	20
0.5 A - 5 A	16 Hz – 450 Hz	0.5 A – 2 A	139	120	50	50	240	50
		2 A – 5 A	130	120	50	50	240	50
	450 Hz – 850 Hz	0.5 A – 2 A	182	120	50	50	360	50
		2 A – 5 A	170	120	50	50	360	50
1 A - 10 A	16 Hz – 450 Hz	1 A – 4 A	191	240	70	100	280	100
		4 A – 10 A	164	240	70	100	280	100
	450 Hz – 850 Hz	1 A – 4 A	267	240	70	100	420	100
		4 A – 10 A	250	240	70	100	420	100
2 A - 21 A	16 Hz – 450 Hz	2 A – 8 A	213	720	90	300	320	300
		8 A – 21 A	189	720	90	300	320	300
	450 Hz – 850 Hz	2 A – 8 A	267	720	90	300	480	300
		8 A – 21 A	250	720	90	300	480	300
8 A - 80 A	40 Hz – 450 Hz	8 A – 32 A	265	2800	120	1200	1000	1200
		32 A – 80 A	250	2800	120	1200	1000	1200
	450 Hz – 850 Hz	8 A – 32 A	300	2800	120	1200	1000	1200
		32 A – 80 A	280	2800	120	1200	1000	1200

[1] for ± 1°C and constant load and connection conditions

[2] When Flicker, Fluctuating harmonics, Dip/Swell or Interharmonics are applied, 'Open loop' stability specification must be added to the 1-year accuracy specification as described in paragraph 1-9

[3] tcal = temperature of last calibration.

[4] Output levels less than the range minimum can be set but are not specified.

[5] These specifications assume a 'sampling' measuring instrument. Some RMS sensing instruments have voltage input bandwidths of several MHz. The 6100A specification should be expanded by the non-harmonic noise floor in table 1-15 for RMS sensing devices.

1-20. Current DC And Harmonic Amplitude Specifications

Range	Output [4][5]	Frequency	1 year accuracy, tcal [1] ± 5°C ± (ppm of output + μA)		'Closed loop' Stability ± (ppm of output + μA) per hour [1]		Open loop' Stability ± (ppm of output + μA) per hour [1][2]	
0.01 A - 0.25 A	0 A – 0.125 A	DC	139	75	50	11	240	11
	0 A – 0.075 A	16 Hz – 450 Hz	139	6	50	3	240	3
		450 Hz – 850 Hz	182	6	50	3	360	3
		850 Hz – 6 kHz	505	6	100	3	1000	3
0.05 A - 0.5 A	0 A – 0.25 A	DC	139	150	50	22	240	22
	0 A – 0.15 A	16 Hz – 450 Hz	139	12	50	5	240	5
		450 Hz – 850 Hz	182	12	50	5	360	5
		850 Hz – 6 kHz	505	12	100	5	1000	5
0.1A -1 A	0 A – 0.5 A	DC	139	300	50	45	240	45
	0 A – 0.3 A	16 Hz – 450 Hz	139	24	50	10	240	10
		450 Hz – 850 Hz	182	24	50	10	360	10
		850 Hz – 6 kHz	505	24	100	10	1000	10
0.2A - 2 A	0 A – 1 A	DC	139	600	50	90	240	90
	0 A – 0.6 A	16 Hz – 450 Hz	139	48	50	20	240	20
		450 Hz – 850 Hz	182	48	50	20	360	20
		850 Hz – 6 kHz	505	48	100	20	1000	20
0.5A - 5 A	0 A – 2.5 A	DC	139	1500	50	225	240	225
	0 A – 1.5 A	16 Hz – 450 Hz	139	120	50	50	240	50
		450 Hz – 850 Hz	182	120	50	50	360	50
		850 Hz – 6 kHz	505	120	100	50	1000	50
1 A - 10 A	0 A – 5 A	DC	191	3000	70	450	280	450
	0 A – 3 A	16 Hz – 450 Hz	191	240	70	100	280	100
		450 Hz – 850 Hz	267	240	70	100	420	100
		850 Hz – 6 kHz	519	240	110	100	1100	100
2 A - 21 A	0 A – 10 A	DC	213	6000	90	900	320	900
	0 A – 6 A	16 Hz – 450 Hz	213	720	90	300	320	300
		450 Hz – 850 Hz	267	720	90	300	480	300
		850 Hz – 6 kHz	665	720	120	300	1300	300
8 A – 80 A	0 A – 24 A	40 Hz – 450 Hz	265	2800	120	1200	1000	1200
		450 Hz – 850 Hz	300	2800	120	1200	1000	1200
		850 Hz – 3 kHz	690	2800	150	1200	2000	1200

[1] tcal = temperature of last calibration.

[2] for $\pm 1^\circ\text{C}$ and constant load and connection conditions

[3] When Flicker, Fluctuating harmonics, Dip/Swell or Interharmonics are applied, 'Open loop' stability specification must be added to the 1-year accuracy specification as described in paragraph 1-9

[4] These specifications are only applicable if the combined voltage RMS output is greater than the range minimum. If the combined output is below the range minimum the output is not specified.

[5] The maximum value for a single harmonic (2nd to 100th) below 2850 Hz is 30% of range. See paragraph 1-8 for profile above 2850 Hz.

1-21. Current Distortion And Noise

Full Range	Frequency	Maximum harmonic distortion [1]				Non-harmonic noise floor (relative to full range) 16Hz to 4MHz	
		the largest of		or the largest of		dB	%
		dB	Amps	% setting	% range		
0.25 A	16 Hz – 850 Hz	-80	7.5 μA	0.010	0.003	-50	0.316
	850 Hz – 6 kHz	-60	25 μA	0.100	0.010	-50	0.316
0.5 A	16 Hz – 850 Hz	-80	15 μA	0.010	0.003	-60	0.100
	850 Hz – 6 kHz	-60	50 μA	0.100	0.010	-60	0.100
1 A	16 Hz – 850 Hz	-80	30 μA	0.010	0.003	-60	0.100
	850 Hz – 6 kHz	-60	100 μA	0.100	0.010	-60	0.100
2 A	16 Hz – 850 Hz	-80	60 μA	0.010	0.003	-65	0.056
	850 Hz – 6 kHz	-60	200 μA	0.100	0.010	-65	0.056
5 A	16 Hz – 850 Hz	-80	150 μA	0.010	0.003	-65	0.056
	850 Hz – 6 kHz	-60	500 μA	0.100	0.010	-65	0.056
10 A	16 Hz – 850 Hz	-80	300 μA	0.010	0.003	-50	0.316
	850 Hz – 6 kHz	-60	1.0 mA	0.100	0.010	-50	0.316
21 A	16 Hz – 850 Hz	-80	600 μA	0.010	0.003	-50	0.316
	850 Hz – 6 kHz	-60	2.0 mA	0.100	0.010	-50	0.316
80A	16 Hz – 850 Hz	-80	2.4 mA	0.100	0.003	-70	0.032
	850 Hz – 3 kHz	-60	8.0 mA	0.100	0.010	-70	0.032

[1] dB harmonic distortion increases linearly between 850Hz and 6kHz

1-22. Maximum Inductive Loading For Output Stability

Full Range (FR)	0.25 A	0.5 A	1 A	2 A	5 A	10 A	21 A	80A
Maximum Inductive load, Hi Bandwidth[1]	300 μH	300 μH	300 μH	300 μH	300 μH	45 μH	100 μH	30 μH
Maximum Inductive load, Lo Bandwidth[1][2]	2 mH	2 mH	1 mH	1 mH	500 μH	360 μH	500 μH	250 μH

[1] The current output will remain stable with the inductive loads shown but may not be able to drive that inductance at all current/frequency/harmonic combinations due to voltage burden limitations.

[2] In low bandwidth mode maximum frequency is 3kHz on all ranges except the 80A range, where the limit is 1.5kHz.

1-23. Voltage From The Current Terminals

1-24. Range Limits And Impedance's

Full Range (FR)	0.25 V	1.5 V	10 V
Max peak [1][2]	0.353 V	2.121 V	14.14 V
Source impedance	1 Ω	6.67 Ω	40.02 Ω
Minimum load impedance to maintain specification [3]	25 kΩ	170 kΩ	1 MΩ

[1] These values apply to sinusoidal, distorted and modulated wave-shapes.

[2] Harmonic phase angle significantly affects the peak value of a non-sinusoidal waveform.

[3] For load less than specified, calculate error from parallel combination of source and load impedance.

1-25. Sine Specifications

Range	Frequency	Output component [3]	1 year accuracy, tcal [4] ± 5°C ± (ppm of output + uV) [5]		‘Closed loop’ Stability ± (ppm of output + uV) for 1 hour [1]		‘Open loop’ Stability ± (ppm of output + uV) for 1 hour [1][2]	
0.05 V - 0.25 V	16 Hz – 450 Hz	0.05 V – 0.1 V	200	30	50	15	240	15
		0.1 V – 0.25 V	200	30	50	15	240	15
	450 Hz – 850 Hz	0.05 V – 0.25 V	231	30	50	15	240	15
0.15 V - 1.5 V	16 Hz – 450 Hz	0.15 V – 0.6 V	200	50	50	25	240	25
		0.6 V – 1.5 V	200	40	50	20	240	25
	450 Hz – 850 Hz	0.15 V – 1.5 V	231	50	50	25	240	25
1 V – 10 V	16 Hz – 450 Hz	1 V – 4 V	200	300	50	150	240	150
		4 V – 10 V	200	240	50	120	240	150
	450 Hz – 850 Hz	1 V – 10 V	231	300	50	150	240	150

[1] For ± 1°C and constant load and connection conditions

[2] When Flicker, Fluctuating harmonics, Dip/Swell or Interharmonics are applied, ‘Open loop’ stability specification must be added to the 1-year accuracy specification as described in paragraph 1-9

[3] Output levels less than the range minimum can be set but are not specified.

[4] tcal = temperature of last calibration.

[5] These specifications assume a ‘sampling’ measuring instrument. Some RMS sensing instruments have voltage input bandwidths of several MHz. The 6100A specification should be expanded by the non-harmonic noise floor in table 1-15 for RMS sensing devices.

1-26. DC And Harmonic Amplitude Specifications

Range	Output [4][5]	Frequency	1 year accuracy, t_{cal} [1] $\pm 5^{\circ}C$ \pm (ppm of output + μV)		'Closed loop' Stability \pm (ppm of output + μV) per hour [1]		Open loop' Stability \pm (ppm of output + μV) per hour [1][2]	
0.05 V - 0.25 V	0 V – 0.125 V	DC	231	75	50	15	240	15
	0 V – 0.075 V	16 Hz – 450 Hz	200	30	50	15	240	15
		450 Hz – 850 Hz	231	30	50	15	240	15
		850 Hz – 6 kHz	1000	30	100	15	1000	15
0.15 V - 1.5 V	0 V – 0.75 V	DC	231	450	50	75	240	75
	0 V – 0.45 V	16 Hz – 450 Hz	200	50	50	25	240	25
		450 Hz – 850 Hz	231	50	50	25	240	25
		850 Hz – 6 kHz	1000	50	100	25	1000	25
1 V – 10 V	0 V – 5 V	DC	231	3000	50	450	240	450
	0 V – 3 V	16 Hz – 450 Hz	200	300	50	150	240	150
		450 Hz – 850 Hz	231	300	50	150	240	150
		850 Hz – 6 kHz	1000	300	100	150	1000	150

[1] t_{cal} = temperature of last calibration.

[2] for $\pm 1^{\circ}C$ and constant load and connection conditions

[3] When Flicker, Fluctuating harmonics, Dip/Swell or Interharmonics are applied, 'Open loop' stability specification must be added to the 1-year accuracy specification as described in paragraph 1-9

[4] These specifications are only applicable if the combined voltage RMS output is greater than the range minimum. If the combined output is below the range minimum the output is not specified.

[5] The maximum value for a single harmonic (2nd to 100th) below 2850 Hz is 30% of range. See paragraph 1-8 for profile above 2850 Hz.

1-27. Voltage From Current Terminals, Distortion And Noise

Full Range	Frequency	Maximum harmonic distortion [1]				Non-harmonic noise floor (relative to full range)	
		Either:				16Hz to 4MHz	
		the largest of		or the largest of		dB	%
		dB	Volts	% setting	% range		
0.25 V	16 Hz – 850 Hz	-80	2.5 μV	0.010	0.001	-50	0.316
	850 Hz – 6 kHz	-60	25 μV	0.100	0.01	-50	0.316
1.5 V	16 Hz – 850 Hz	-80	15 μV	0.010	0.001	-60	0.100
	850 Hz – 6 kHz	-60	150 μV	0.100	0.01	-60	0.100
10 V	16 Hz – 850 Hz	-80	100 μV	0.010	0.001	-60	0.100
	850 Hz – 6 kHz	-60	1 mV	0.100	0.01	-60	0.100

[1] dB harmonic distortion increases linearly between 50Hz and 6kHz

1-28. Current To Voltage Phase Specifications

Note: For phase specifications of voltage from the current terminals, use 0.25 A to 5 A specification from the Current to Voltage Phase specifications.

For all voltage ranges (16 V to 1008V)		Voltage and current components >40% of range		Voltage or current component 0.5% to 40% of range [5]	
Current range	Frequency	1 year accuracy, tcal [4] ± 5°C [1][2]	Stability per hour [2][3]	1 year accuracy, tcal ± 5°C [1][2]	Stability per hour [2][3]
0.25 A to 5 A	16 Hz – 69 Hz	0.003°	0.0002°	0.010°	0.001°
	69 Hz – 180 Hz	0.005°	0.0002°	0.017°	0.002°
	180 Hz – 450 Hz	0.015°	0.0005°	0.050°	0.005°
	450Hz – 850 Hz	0.030°	0.0008°	0.070°	0.018°
	850 Hz – 3 kHz	0.150°	0.0010°	0.200°	0.100°
	3 kHz – 6 kHz	0.300°	0.0010°	0.450°	0.100°
5 A to 21 A	16 Hz – 69 Hz	0.004°	0.0003°	0.013°	0.002°
	69 Hz – 180 Hz	0.007°	0.0003°	0.023°	0.004°
	180 Hz – 450 Hz	0.020°	0.0005°	0.065°	0.010°
	450Hz – 850 Hz	0.040°	0.0008°	0.080°	0.020°
	850 Hz – 3 kHz	0.200°	0.0015°	0.250°	0.100°
	3 kHz – 6 kHz	0.400°	0.0020°	0.600°	0.150°
20 A to 80 A	16 Hz – 69 Hz	0.004°	0.0005°	0.016°	0.003°
	69 Hz – 180 Hz	0.008°	0.0005°	0.028°	0.005°
	180 Hz – 450 Hz	0.025°	0.0010°	0.080°	0.015°
	450Hz – 850 Hz	0.050°	0.0015°	0.100°	0.030°
	850 Hz – 3 kHz	0.250°	0.0020°	0.300°	0.150°

[1] phase errors relative to L1 Voltage

[2] phase angle contribution to power accuracy varies with set phase angle see section 1-29 below

[3] for constant load and connection conditions

[4] tcal = temperature of last calibration.

[5] phase performance at less than 0.5% of full range degrades as output components approach the resolution limit of the digital feedback system.

1-29. Power Specifications

The example power specifications below are only valid for RMS values greater than 40% of range for voltage and current and frequency less than 450Hz. They are not valid when any of: Flicker, Fluctuating harmonics, Dip/Swell or Interharmonics are applied to the voltage or current channel of that 6100A/6101A.

1-30. Sinusoidal VA Specifications

The following table shows in parts per million the minimum to maximum VA accuracy for specific voltage and current bands under sinusoidal conditions.

V Range	16 V	33 V	78 V	168 V	336 V	1008 V
I Setting	(6.4 to 16 V)	(13.2 to 33 V)	(31 to 78 V)	(67 to 168 V)	(134 To 336V)	(330 to 1008 V)
0.1 to 5 A	233 to 329	220 to 295	206 to 259	207 to 260	207 to 260	240 to 304
5.1 to 10 A	256 to 341	245 to 309	233 to 275	233 to 276	233 to 276	263 to 317
10.1 to 21 A	284 to 373	274 to 344	263 to 314	264 to 315	264 to 315	290 to 352
20.1 to 80 A	347 to 485	339 to 463	330 to 441	330 to 442	330 to 442	352 to 469

1-31. Sinusoidal Power Specifications

The following tables show in parts per million the minimum to maximum Power accuracy for specific voltage and current bands under sinusoidal conditions.

1-32. 16hz to 69hz, 1.0 > Power Factor > 0.75

V Range	16 V	33 V	78 V	168 V	336 V	1008 V
I Setting	(6.4 to 16 V)	(13.2 to 33 V)	(31 to 78 V)	(67 to 168 V)	(134 to 336V)	(330 to 1008 V)
0.1 to 2 A	237 to 323	225 to 288	212 to 252	212 to 253	212 to 253	244 to 297
2.1 to 5 A	241 to 333	229 to 299	215 to 264	216 to 265	216 to 265	248 to 308
5.1 to 10 A	264 to 347	253 to 315	241 to 282	241 to 283	241 to 283	270 to 323
10.1 to 21 A	291 to 378	281 to 350	270 to 320	271 to 321	271 to 321	297 to 357
20.1 to 80 A	398 to 489	391 to 467	383 to 445	384 to 446	384 to 446	402 to 473

1-33. 16Hz to 69Hz, 0.75 > Power Factor > 0.5

V Range	16 V	33 V	78 V	168 V	336 V	1008 V
I Setting	(6.4 to 16 V)	(13.2 to 33 V)	(31 to 78 V)	(67 to 168 V)	(134 to 336V)	(330 to 1008 V)
0.1 to 2 A	250 to 332	238 to 299	225 to 264	226 to 264	226 to 264	257 to 307
2.1 to 5 A	262 to 349	251 to 317	239 to 284	240 to 285	240 to 285	269 to 325
5.1 to 10 A	283 to 362	273 to 332	262 to 300	263 to 301	263 to 301	290 to 340
10.1 to 21 A	309 to 393	300 to 365	290 to 337	290 to 337	290 to 337	315 to 372
20.1 to 80 A	411 to 500	404 to 478	397 to 457	397 to 458	397 to 458	416 to 484

1-34. 16Hz to 69Hz, 0.5 > Power Factor > 0.25

V Range	16 V	33 V	78 V	168 V	336 V	1008 V
I Setting	(6.4 to 16 V)	(13.2 to 33 V)	(31 to 78 V)	(67 to 168 V)	(134 to 336V)	(330 to 1008 V)
0.1 to 2.1 A	309 to 378	299 to 349	289 to 320	290 to 321	290 to 321	314 to 357
2.1 to 5 A	357 to 424	349 to 399	340 to 373	340 to 374	340 to 374	362 to 405
5.1 to 10 A	373 to 435	365 to 410	357 to 386	357 to 386	357 to 386	377 to 417
10.1 to 21 A	392 to 461	385 to 438	377 to 414	378 to 415	378 to 415	397 to 444
20.1 to 80 A	477 to 555	471 to 536	465 to 517	465 to 518	465 to 518	481 to 541

1-35. 69Hz to 180Hz, 1.0 > Power Factor > 0.75

V Range	16 V	33 V	78 V	168 V	336 V	1008 V
I Setting	(6.4 to 16 V)	(13.2 to 33 V)	(31 to 78 V)	(67 to 168 V)	(134 to 336V)	(330 to 1008 V)
0.1 to 2 A	245 to 329	233 to 295	220 to 259	221 to 260	221 to 260	252 to 304
2.1 to 5 A	256 to 344	245 to 312	233 to 279	233 to 280	233 to 280	263 to 321
5.1 to 10 A	278 to 358	268 to 327	257 to 295	257 to 296	257 to 296	284 to 335
10.1 to 21 A	304 to 389	295 to 361	285 to 332	285 to 333	285 to 333	310 to 368
20.1 to 80 A	412 to 500	405 to 479	398 to 458	398 to 458	398 to 458	416 to 485

1-36. 69Hz to 180Hz, 0.75 > Power Factor > 0.5

V Range	16 V	33 V	78 V	168 V	336 V	1008 V
I Setting	(6.4 to 16 V)	(13.2 to 33 V)	(31 to 78 V)	(67 to 168 V)	(134 to 336V)	(330 to 1008 V)
0.1 to 2 A	277 to 353	267 to 322	256 to 290	256 to 291	256 to 291	284 to 330
2.1 to 5 A	314 to 389	305 to 361	296 to 333	296 to 334	296 to 334	320 to 369
5.1 to 10 A	332 to 401	324 to 374	315 to 347	315 to 348	315 to 348	338 to 381
10.1 to 21 A	354 to 429	346 to 404	338 to 379	338 to 379	338 to 379	359 to 410
20.1 to 80 A	462 to 542	455 to 522	449 to 503	449 to 503	449 to 503	465 to 527

1-37. 69Hz to 180Hz, 0.5 > Power Factor > 0.25

V Range	16 V	33 V	78 V	168 V	336 V	1008 V
I Setting	(6.4 to 16 V)	(13.2 to 33 V)	(31 to 78 V)	(67 to 168 V)	(134 to 336V)	(330 to 1008 V)
0.1 to 2 A	410 to 465	403 to 442	396 to 419	396 to 419	396 to 419	415 to 448
2.1 to 5 A	527 to 575	522 to 557	516 to 539	516 to 539	516 to 539	531 to 561
5.1 to 10 A	538 to 583	533 to 565	527 to 547	528 to 548	528 to 548	541 to 570
10.1 to 21 A	552 to 603	547 to 585	542 to 568	542 to 568	542 to 568	555 to 590
20.1 to 80 A	669 to 726	664 to 712	660 to 698	660 to 698	660 to 698	671 to 716

1-38. 180Hz to 450Hz, 1.0 > Power Factor > 0.75

V Range	16 V	33 V	78 V	168 V	336 V	1008 V
I Setting	(6.4 to 16 V)	(13.2 to 33 V)	(31 to 78 V)	(67 to 168 V)	(134 to 336V)	(330 to 1008 V)
0.1 to 2 A	328 to 394	319 to 366	310 to 338	310 to 339	310 to 339	333 to 374
2.1 to 5 A	386 to 449	378 to 425	371 to 401	371 to 402	371 to 402	390 to 431
5.1 to 10 A	401 to 460	394 to 436	386 to 413	386 to 413	386 to 413	405 to 442
10.1 to 21 A	419 to 484	412 to 462	405 to 440	405 to 440	405 to 440	423 to 467
20.1 to 80 A	550 to 619	545 to 602	540 to 585	540 to 586	540 to 586	553 to 606

1-39. 180Hz to 450Hz, 0.75 > Power Factor > 0.5

V Range	16 V	33 V	78 V	168 V	336 V	1008 V
I Setting	(6.4 to 16 V)	(13.2 to 33 V)	(31 to 78 V)	(67 to 168 V)	(134 to 336V)	(330 to 1008 V)
0.1 to 2 A	510 to 555	504 to 535	498 to 517	498 to 517	498 to 517	513 to 540
2.1 to 5 A	648 to 687	643 to 672	639 to 657	639 to 657	639 to 657	651 to 676
5.1 to 10 A	657 to 694	652 to 679	648 to 664	648 to 665	648 to 665	659 to 683
10.1 to 21 A	668 to 711	664 to 696	660 to 681	660 to 682	660 to 682	671 to 700
20.1 to 80 A	852 to 898	849 to 886	845 to 875	845 to 875	845 to 875	854 to 889

1-40. 180Hz to 450Hz, 0.5 > Power Factor > 0.25

V Range	16 V	33 V	78 V	168 V	336 V	1008 V
I Setting	(6.4 to 16 V)	(13.2 to 33 V)	(31 to 78 V)	(67 to 168 V)	(134 to 336V)	(330 to 1008 V)
0.1 to 2 A	1040 to 1063	1038 to 1053	1035 to 1044	1035 to 1044	1035 to 1044	1042 to 1056
2.1 to 5 A	1372 to 1391	1370 to 1383	1368 to 1376	1368 to 1376	1368 to 1376	1373 to 1385
5.1 to 10 A	1376 to 1394	1374 to 1387	1372 to 1380	1372 to 1380	1372 to 1380	1377 to 1389
10.1 to 21 A	1382 to 1403	1380 to 1395	1377 to 1388	1377 to 1388	1377 to 1388	1383 to 1397
20.1 to 80 A	1735 to 1758	1734 to 1752	1732 to 1747	1732 to 1747	1732 to 1747	1736 to 1754

1-41. Power Factor < 0.25

For Power Factor less than 0.25, phase angle dominates power specifications and voltage and current accuracy becomes negligible. Calculate Power uncertainty from:

$$u(P) = \left(1 - \frac{\cos(\Phi + u(\phi))}{\cos(\Phi)}\right) \times 10^6 \text{ ppm}$$

where Φ is the set phase angle and $u(\phi)$ is the phase uncertainty.

1-42. Reactive Power, Power Factor < 0.25

Use the relevant frequency table for Power, 1.0 > Power Factor > 0.75

1-43. Reactive Power, 0.25 > Power Factor > 0.5

Use the relevant frequency table for Power, 0.75 > Power Factor > 0.5

1-44. Reactive Power, 0.5 > Power Factor > 0.75

Use the relevant frequency table for Power, 0.5 > Power Factor > 0.25

1-45. Reactive Power, Power Factor > 0.75

For reactive Power (Q) where power factor > 0.75 calculate $u(Q)$ from

$$u(Q) = \left(1 - \frac{\sin(\Phi + u(\phi))}{\sin(\Phi)}\right) \times 10^{-6} \text{ ppm}$$

The method used for calculation of reactive power in non-sinusoidal conditions is user selectable.

1-46. Reactive Power Calculation Methods

Under pure sinusoidal conditions, Apparent Power (S), Power (P) and Reactive power (Q) are related by: $S^2 = P^2 + Q^2$. This relationship is known as the Power Triangle. When either the voltage or current waveform is not sinusoidal, the power triangle is not satisfied by this equation. This has led to various attempts to better define Reactive Power (Q) but no single definition has been agreed. The difficulty is that Q is used for a number of different calculations including transmission line efficiency and voltage line drop. The 6100A/6101A allows users to select the definition that best meets their needs. The following methods are supported.

Budeanu	Fryze
Kusters and Moore	Shepherd and Zakikhani
Sharon	Czarnecki
IEEE working group	IEC working group TC 25/ WG 7

Because of the complexity of the subject, definition of the methods listed is beyond the scope of this document. References to relevant documentation are provided at 1-67.

1-47. Flicker Specifications

Although Flicker is a primarily a voltage phenomena the 6100A provides the same facility on its current output. Flicker is not available on a voltage or current channel if Fluctuating Harmonics are already enabled on that channel.

1-48. Voltage and Current Flicker Specification

Setting range	±30% of set voltage or current within range values (60% ΔV/V)
Flicker modulation depth accuracy	±0.025%
Modulation depth setting resolution	0.001%
Shape	Rectangular or Sinusoidal
Duty cycle (shape = rectangular)	0.01 % to 99.99 %
Modulating Frequency range	0.0008Hz to 40Hz
Sine modulating frequency accuracy	±(50ppm + 10 μHz)
Rectangular modulating frequency accuracy	< 1300ppm [1]
Modulating Frequency setting resolution	0.0001 Hz

[1] Accuracy is ± {(50 + 31 x modulating frequency) ppm + 10 μHz}

1-49. Pst Indication Accuracy

Pst values are from IEC 60868 table 1. Note that Pst indications are strictly only valid for rectangular modulation shape and at 230 V, 50Hz and 120V, 60Hz. Pst values interpolated for modulating frequency values between those tabulated in IEC 60868 are displayed with a leading ≈ symbol. PST values are not valid for current.

Voltage setting	P _{st} indication accuracy
220 V to 240 V	±0.25%
115 V to 125 V	±0.25%

Note that long term flicker (Plt) can be simulated either by a steady Pst over a suitable period, or by changing Pst and calculating Plt from:

$$P_{lt} = \sqrt[3]{\frac{\sum_{i=1}^N P_{sti}^3}{N}}$$

where P_{sti} (i=1,2,3, ...) are different consecutive readings of Pst. See IEC61000-4-15 for details.

1-50. Fluctuating Harmonic Specifications

Fluctuating harmonics are available on voltage and current outputs. Fluctuating Harmonics are not available on a voltage or current channel if Flicker is already enabled on that channel.

Number of harmonics to fluctuate	Any number from 0 to all set harmonics can fluctuate
Modulation depth setting range [1]	0% to 100% of nominal harmonic voltage
Fluctuation accuracy (0% to ± 30% modulation)	±0.025%
Modulation depth setting resolution	0.001%
Shape	Rectangular or Sinusoidal
Duty cycle (shape = rectangular)	0.1 % to 99.99 %
Modulating Frequency range	0.008Hz to 30Hz
Sine modulating frequency accuracy	±(50ppm + 10 μHz)
Rectangular modulating frequency accuracy	< 1300ppm [2]
Modulating Frequency setting resolution	0.001 Hz

[1] Fluctuation accuracy is not specified for modulation depth > ± 30%.

[2] Accuracy is ± {(50 + 31 x modulating frequency) ppm + 10 μHz. }

1-51. Interharmonic Specifications

Interharmonics are available on voltage and current outputs

Frequency accuracy	±500ppm
Amplitude accuracy 16Hz to < 6kHz	±1%
Amplitude accuracy > 6kHz	4%
Maximum value of a single interharmonic	The maximum value for an interharmonic < 2850 Hz is 30% of range. See paragraph 1-8 for profile above 2850 Hz.
Frequency range of interharmonic	16Hz to 9kHz

1-52. Dip/Swell Specifications

Although Dips and Swells are primarily a voltage phenomena the 6100A provides the same facility on its current output.

Trigger in requirement	TTL falling edge remaining low for 10us
Either: Trigger in delay OR Phase angle synchronization with respect to channel fundamental frequency zero crossing	0 to 60 seconds \pm 31 μ s \pm 180 $^\circ$ \pm 31 μ s
Dip/Swell Min duration	1 ms
Dip/Swell Max duration	1 minute
Dip Min amplitude	0% of the nominal output
Swell Max amplitude	The least of full range value and 140% of the nominal output
Ramp up/down period	Settable 100 μ s to 30 seconds
Optional repeat with delay	0 to 60 seconds \pm 31 μ s
Starting level amplitude accuracy	\pm 0.025% of level
Dip/Swell level amplitude accuracy [1]	\pm 0.25% of level
Trigger out delay	0 to 60 seconds \pm 31 μ s from start of dip/swell event
Trigger out	TTL falling edge co-incident with end of trigger out delay, remaining low for 10 μ s to 31 μ s

[1] Accuracy not specified below 10% of starting level or below the range minimum value.

1-53. Multi-Phase Operation

1-54. Voltage Channel To Voltage Channel Phase Specifications

For all voltage ranges (16 V to 1008V)	Voltage components >40% of range		Voltage components 0.5% to 40% of range [4]	
	1 year accuracy, tcal [3] \pm 5 $^\circ$ C [1]	Stability per hour [2]	1 year accuracy, tcal [3] \pm 5 $^\circ$ C [1]	Stability per hour [2]
Frequency				
16 Hz – 69 Hz	0.005 $^\circ$	0.0002 $^\circ$	0.010 $^\circ$	0.001 $^\circ$
69 Hz – 180 Hz	0.007 $^\circ$	0.0002 $^\circ$	0.018 $^\circ$	0.002 $^\circ$
180 Hz – 450 Hz	0.025 $^\circ$	0.0005 $^\circ$	0.052 $^\circ$	0.005 $^\circ$
450 Hz to 850 Hz	0.050	0.0008 $^\circ$	0.075 $^\circ$	0.018 $^\circ$
850 Hz to 3 kHz	0.170 $^\circ$	0.0010 $^\circ$	0.220 $^\circ$	0.100 $^\circ$
3 kHz to 6 kHz	0.350 $^\circ$	0.0015 $^\circ$	0.400 $^\circ$	0.150 $^\circ$

[1] phase errors relative to L1 Voltage

[2] for constant load and connection conditions.

[3] tcal = temperature of last calibration.

[4] phase performance at less than 0.5% of full range degrades as output components approach the resolution limit of the digital feedback system.

1-55. General Specifications

1-56. Input Power

Voltage	100 V to 240 V with up to $\pm 10\%$ fluctuations
Transient overvoltages	Impulse withstand (overvoltage) category II of IEC 60364-4-443
Frequency:	47 Hz to 63 Hz
Max. Consumption	1000 VA max from 100 to 130V, 1250 VA max from 130V to 260V

1-57. Dimensions

	6100A and 6101A	6100A/80A and 6101A/80A
Height	233 mm (9.17 inches)	324 mm (12.8 inches)
Height (without feet)	219 mm (8.6 inches)	310 mm (12.2 inches)
Width	432 mm (17 inches)	432 mm (17 inches)
Depth	630 mm (24.8 inches)	630 mm (24.8 inches)
Weight	23 kg (51 lb)	30 kg (66 lb)

1-58. Environment

Operating temperature	5 °C to 35 °C
Calibration temperature (tcal) range	16 °C to 30 °C
Storage temperature	0 °C to 50 °C
Transit temperature	-20 °C to 60 °C < 100 hours
Warm up time	1 hour
Safe Operating Max. Relative Humidity (non-condensing)	< 80% 5 °C to 31 °C ramping linearly down to 50% at 35 °C
Storage Max Relative Humidity (non-condensing)	<95% 0 °C to 50 °C
Operating altitude	0 m to 2,000 m
Non operating altitude	0 m to 12,000 m
Shock	MIL-PRF-28800F class 3
Vibration	MIL-PRF-28800F class 3
Enclosure	MIL-PRF-28800F class 3

1-59. Safety

Designed to EN61010-1: 2001, CAN/CSA 22.2 No 1010.1-92, UL61010A-1

Indoor use only, pollution degree 2; installation category II

CE marked and ETL listed

1-60. EMC

EN61326: 2002, class A, FCC rules part 15, sub-part B, class A (Class A equipment is suitable for use in establishments other than domestic, and those directly connected to a low voltage power supply network which supplies buildings used for domestic purposes).

1-61. Determining non-sinusoidal waveform amplitude specifications

The RMS value of the combination of voltage components is:

$$V_{RMS}^2 = \sum_{i=1}^N V_i^2 \text{ and, assuming symmetrical uncertainties, } u(V)_i, \text{ for each of } V_i,$$

Note that the uncertainties of the components of a 6100A nonsinusoidal voltage (or current) waveform are correlated so must be combined by linear addition.

$$(V_{RMS} + u(V_{RMS}))^2 = \sum_{i=1}^N (V_i + u(V_i))^2$$

$$V_{RMS}^2 + 2V_{RMS}u(V_{RMS}) + u^2(V_{RMS}) =$$

$$V_1^2 + 2V_1u(V_1) + u^2(V_1) + V_2^2 + 2V_2u(V_2) + u^2(V_2) \dots V_n^2 + 2V_nu(V_n) + u^2(V_n)$$

But $V_{RMS}^2 = \sum_{i=1}^N V_i^2,$

and, where uncertainties are relatively small (as in the 6100A), u^2v_i components become negligible. The uncertainty of the combined waveform becomes:

$$2V_{RMS}u(V_{RMS}) = 2V_1u(V_1) + 2V_2u(V_2) \dots 2V_nu(V_n)$$

which simplifies to give u_c as the combined uncertainty:

$$u_c(V_{RMS}) = \sum_{i=1}^N c_i u(V_i)$$

where $c_i = \frac{V_i}{V_{RMS}}$ and is known as the sensitivity coefficient.

1-62. Non-sinusoidal voltage example

The waveform is a 60Hz, 110V RMS waveform, from the 168V range, comprising 10% 95th harmonic, 30% 3rd harmonic with the remainder contributed by the fundamental frequency. Using the voltage uncertainty values in paragraph 1-12 and 1-13, determine the 1-year accuracy.

$$3^{\text{rd}} \text{ Harmonic RMS voltage} = 0.3 \times 110 = 33\text{V}$$

$$95^{\text{th}} \text{ Harmonic RMS voltage} = 0.1 \times 110 = 11\text{V}$$

$$\text{Fundamental RMS voltage} = \sqrt{(110^2 - 33^2 - 11^2)} = 104.3552\text{V}$$

Accuracy contribution from the fundamental:

$$112\text{ppm of output} + 4.4\text{mV} = (104.3552 \times 0.000112) + 0.0044 = 0.011688 + 0.0044 = 0.016088\text{V}$$

$$\text{Modified by the sensitivity coefficient} = 0.016088 \times 104.3552 \div 110 = 0.015262\text{V}$$

Accuracy contribution from the 3rd Harmonic (180Hz):

$$122\text{ppm of } 3^{\text{rd}} \text{ harmonic value} + 4.4\text{mV} = (0.000122 \times 33) + 0.0044 = 0.008426\text{V}$$

$$\text{Modified by the sensitivity coefficient} = 0.008426 \times 33 \div 110 = 0.002528\text{V}$$

Accuracy contribution from the 95th Harmonic (5700Hz):
 512ppm of 95th harmonic value+4.4mV = (0.000512x11)+0.0044 = 0.010032V
 Modified by the sensitivity coefficient = 0.010032x11 ÷ 110 = 0.001003V

Combining the uncertainties:
 Total amplitude uncertainty = 0.015262+0.002528+0.0010032 = 0.018793V

Voltage Accuracy = 110 ± 0.018793 V

1-63. Apparent power (S) accuracy calculations

For the purpose of calculation of apparent power (S) for nonsinusoidal outputs the following equations are used:

$$S = \sqrt{\sum_n V_n^2 \sum_n I_n^2} \text{ VA}$$

To calculate the accuracy of apparent power (S), the amplitude accuracy specifications of voltage harmonic components must be combined as described in paragraph 1-61 above. Current components are combined using the same method. As apparent power is the product of two different quantities, uncertainties are conveniently combined using relative values. Note that 6100A voltage and current components are generated independently and are therefore largely uncorrelated.

As $S^2 = V_{RMS}^2 \cdot I_{RMS}^2$;

$$\frac{u_c^2(S)}{S^2} = \left[\frac{u(V_{RMS})}{V_{RMS}} \right]^2 + \left[\frac{u(I_{RMS})}{I_{RMS}} \right]^2$$

where $u_c(S)$ is the combined uncertainty of the apparent Power,
 $u(V_{RMS})$ is the uncertainty of the RMS voltage and
 $u(I_{RMS})$ is the uncertainty of the RMS current.

1-64. Apparent power example

Voltage channel fundamental frequency output is 109V on the 168V range at 60Hz. A 15V 3rd harmonic has been added. The current channel output is 7A at 60Hz on the 10A range with 3rd and 5th harmonics at 0.7A and 0.3A respectively. Phase angles are not relevant to the calculation of apparent power. Voltage uncertainty values are given in paragraph 1-12 and 1-13, current uncertainty values are given in paragraph 1-19 and 1-20

The voltage RMS value is $\sqrt{109^2 + 15^2} = 110.02727 \text{ V}$
 Accuracy contribution from the voltage fundamental:
 112ppm of 109V+4.4mV = (109x0.000112)+0.0044 = 0.012208+0.0044 = 0.016608V
 Modified by the sensitivity coefficient = 0.016608x109 ÷ 110.02727 = 0.016453V

Accuracy contribution from the voltage 3rd harmonic:

$$122\text{ppm of } 15\text{V}+4.4\text{mV} = (15 \times 0.000112) + 0.0044 = 0.01830 + 0.0044 = 0.006230\text{V}$$

$$\text{Modified by the sensitivity coefficient} = 0.006230 \times 15 \div 110.02727 = 0.000849\text{V}$$

Combined voltage uncertainty:

$$\frac{u(V_{RMS})}{V_{RMS}} = \frac{0.016453 + 0.000849}{110.02727} = 0.000157 \text{ (or 157 ppm)}.$$

$$\text{The current RMS value is } \sqrt{7^2 + 0.7^2 + 0.3^2} = 7.041307$$

Accuracy contribution from the current fundamental:

$$164\text{ppm of } 7\text{A}+240\mu\text{A} = (7 \times 0.000164) + 0.000240 = 0.001148 + 0.000240 = 0.001388$$

$$\text{Modified by the sensitivity coefficient} = 0.001388 \times 7 \div 7.041307 = 0.001380\text{A}$$

Accuracy contribution from the current 3rd harmonic:

$$191\text{ppm of } 0.7\text{A}+240\mu\text{A} = (0.7 \times 0.000191) + 0.000240 = 0.000134 + 0.000240 = 0.000374$$

$$\text{Modified by the sensitivity coefficient} = 0.000374 \times 0.7 \div 7.041307 = 0.000037\text{A}$$

Accuracy contribution from the current 5th harmonic:

$$191\text{ppm of } 0.3\text{A}+240\mu\text{A} = (0.3 \times 0.000191) + 0.000240 = 0.000058 + 0.000240 = 0.000297$$

$$\text{Modified by the sensitivity coefficient} = 0.000297 \times 0.3 \div 7.041307 = 0.000013\text{A}$$

Combined current uncertainty:

$$\frac{u(I_{RMS})}{I_{RMS}} = \frac{0.001388 + 0.000037 + 0.000013}{7.041307} = 0.000204 \text{ (or 204 ppm)}.$$

$$\text{Now, } S^2 = V_{RMS}^2 \cdot I_{RMS}^2 = 110.02727 \times 7.041307 = 774.7358 \text{ VA}$$

Apparent Power uncertainty:

$$\frac{u(S)}{S} = \sqrt{\left[\frac{u(V_{RMS})}{V_{RMS}}\right]^2 + \left[\frac{u(I_{RMS})}{I_{RMS}}\right]^2} = \sqrt{0.000157^2 + 0.000204^2} = 0.0002574$$

giving:

$$u_c^2(S) = 0.0002574 \times 774.735748 = 0.1994 \text{ VA}$$

$$\underline{\underline{\text{Apparent Power Accuracy} = 774.7358 \pm 0.1994 \text{ VA}}}$$

1-65. Power (P) accuracy calculations

Real power is the sum of the products of volt/current/phase accuracy at each harmonic frequency.

$$P = \sum V_n I_n \cos \Phi_n \text{ Watts}$$

where n is the harmonic order of the components.

Calculation of power accuracy uses the same techniques shown previously. The uncorrelated uncertainty components of voltage, current and phase are combined using root sum of squares for each frequency.

$$\frac{u^2(P_f)}{P_f^2} = \left[\frac{u(V_f)}{V_f} \right]^2 + \left[\frac{u(I_f)}{I_f} \right]^2 + \left[\frac{u(\text{phase}_f)}{\text{phase}_f} \right]^2$$

where $u(x)$ is the uncertainty of the component x and phase is the phase angle between the current and voltage at frequency f . It is easiest to express each of these contributions as ppm.

The contribution of phase angle accuracy varies with the set phase angle as shown below.

$$u(\text{phase}) = 1 - \frac{\cos(\Phi + u(\phi))}{\cos \Phi}$$

where Φ is the set phase angle and $u(\phi)$ is the phase accuracy.

The power uncertainties for each frequency, modified by the appropriate sensitivity coefficient c_i , are then linearly summed to give the combined uncertainty u_c (linearly summed because voltage components are correlated, as are those of current and phase).

$$u_c(P) = \sum_{i=1}^N c_i u(P_i)$$

1-66. Power example

Voltage channel output is 109V on the 168V range at 60Hz with 3rd harmonic at 15V. The voltage 3rd harmonic has 0° phase angle relative to the voltage fundamental.

The current channel output is 7A on the 10A range at 60Hz with 3rd and 5th harmonics at 0.7A and 0.3A respectively. The current fundamental phase angle is 12° relative to the voltage fundamental. The current 3rd harmonic has a phase angle of +25° relative to the current fundamental, i.e., the phase angle between the 3rd current harmonic and the 3rd voltage harmonic is 25° + (3 × 12°) = 61°. As the current 5th harmonic is not matched by a voltage 5th harmonic, there is no 5th harmonic power contribution.

Voltage uncertainty values are given in paragraph 1-12 and 1-13, current uncertainty values are given in paragraph 1-19 and 1-20. Phase uncertainty values are given in paragraph 1-28.

Converting all values to ppm, accuracy contribution at the fundamental frequency

$$u(V_1) = 112 \text{ ppm} + \frac{0.0044 \text{ V} \times 10^6}{109 \text{ V}} = 152 \text{ ppm}$$

$$u(I_1) = 164 \text{ ppm} + \frac{0.00024 \text{ A} \times 10^6}{7 \text{ A}} = 198 \text{ ppm}$$

$$u(\text{phase}_1) = \left(1 - \frac{\cos(12 + 0.004)}{\cos(12)} \right) \times 1e6 = 15 \text{ ppm}$$

Combined accuracy for the fundamental frequency components:

$$u(P_1) = \sqrt{152^2 + 198^2 + 15^2} = 250 \text{ ppm}$$

Power in the fundamental frequency:

$$P_1 = V_1 I_1 \cos \Phi_1 = 109 \times 7 \times 0.9781476 = 746.3266 \text{ Watts so:}$$

$$u(P_1) = 250 \times 10^{-6} \times 746.3266 = 0.1866 \text{ Watts}$$

Accuracy contribution for the 3rd harmonic

$$u(V_3) = 122 \text{ ppm} + \frac{0.0044 \text{ V} \times 10^6}{15 \text{ V}} = 415 \text{ ppm}$$

$$u(I_3) = 191 \text{ ppm} + \frac{0.00024 \text{ A} \times 10^6}{0.7 \text{ A}} = 534 \text{ ppm}$$

$$u(\text{phase}_3) = \left(1 - \frac{\cos(61 + 0.023)}{\cos(61)} \right) \times 1e6 = 724 \text{ ppm}$$

Combined accuracy for the 3rd harmonic components

$$u(P_3) = \sqrt{415^2 + 534^2 + 724^2} = 991 \text{ ppm}$$

Power in the 3rd harmonic components:

$$P_3 = V_3 I_3 \cos \Phi_3 = 15 \times 0.7 \times 0.484810 = 5.0905 \text{ Watts so:}$$

$$u(P_3) = 991 \times 10^{-6} \times 5.0905 = 0.005045 \text{ Watts}$$

$$\text{Total power } P = P_1 + P_3 = 746.3266 + 5.0905 = 751.4171 \text{ Watts}$$

From:

$$u_c(P) = \sum_{i=1}^N c_i \cdot u(P_i)$$

$$u_c(P) = \frac{746.3266}{751.4171} \times 0.1866 + \frac{5.0905}{751.4171} \times 0.005045 = 0.1854 \text{ Watts}$$

$$\underline{\text{Power Accuracy} = 751.4171 \pm 0.1854 \text{ Watts}}$$

1-67. References

6100A and 6101A reactive power calculations are guided by the published work of Dr. Stefan Svensson:

Svensson, S., (1999), *Power Measurement Techniques for Nonsinusoidal Conditions*, Chalmers

Other pertinent papers are:

Budeanu, C., (1927), "Reactive and fictitious powers", *Rumanian National Institute*, No.2.

Czarnecki, L. S., (1885), "Considerations on the reactive power in nonsinusoidal situations", *IEEE Trans. on Inst. and Meas.*, Vol. 34, No. 3, pp399-404, Sept.

Czarnecki, L. S., (1987), "What is wrong with the Budeanu concept of reactive and distortion power and why it should be abandoned", *IEEE Trans. on Inst. and Meas.*, Vol. 36, No. 3, pp834-837, Sept

Filipski, P., (1980), "A new approach to reactive current and reactive power measurements in nonsinusoidal systems", *IEEE Trans. on Inst. and Meas.*, Vol. 29, No. 4, pp423-426, Dec.

Fryze, S., (1932), "Wirk- Blind- und Scheinleistung in elektrischen Stromkreisen mit nichtsinusformigen Verlauf von Strom und Spannung", *Elektrotechnische Zeitschrift*, No25, pp 596-99, 625-627, 700-702.

Kusters, N. L. and Moore, W. J. M., (1980), "On the definition of reactive power under nonsinusoidal conditions", *IEEE Transaction on Power Apparatus and Systems*, Vol PAS-99, No. 5, pp1845-1854, Sept/Oct.

Sharon, D., (1973), "Reactive power definition and power factor improvement in non-linear systems", *PROC. IEE*, Vol. 120, No. 6, pp 704-706, July.

Shepherd, W. and Zakikhani, P., (1972), "Suggested definition of reactive power for nonsinusoidal systems", *PROC. IEE*, Vol. 119, No. 9, pp 1361-1362, Sept.

IEC, Reactive power in nonsinusoidal situations, Report TC 25/wg7.

Chapter 2

Installation

	Title	Page
2-1.	Introduction	2-3
2-2.	Unpacking and Inspection	2-3
2-3.	Reshipping the 6100A	2-3
2-4.	Placement and Rack Mounting	2-3
2-5.	Cooling Considerations	2-4
2-6.	Line Voltage	2-4
2-7.	Connecting to Line Power	2-4
2-8.	Connecting 6101A Auxiliary units.....	2-5
2-9.	Allocation of phases	2-5

2-1. Introduction

⚠ WARNING

The 6100A Electrical Power Standard can supply lethal voltages to the binding posts of Master and Auxiliary units.

This chapter provides instructions for unpacking and installing the 6100A Electrical Power Standard. The procedures for fuse replacement, and connection to line power are provided here. Read this chapter before operating the 6100A Electrical Power Standard.

Instructions for cable connections other than line power connection can be found in the following chapters of the manual:

Voltage and Current output connections and instructions for use of the 6100A lead set can be found in Chapter 4

IEEE-488 interface bus connection: Chapter 5

2-2. Unpacking and Inspection

The 6100A Electrical Power Standard is shipped in a container designed to prevent damage during shipping.

Inspect the 6100A Electrical Power Standard carefully for damage, and immediately report any damage to the shipper. Instructions for inspection and claims are included in the shipping container.

A packing list is included in the packaging. When you unpack the 6100A Electrical Power Standard, check for all the standard equipment listed and check the shipping order for any additional items ordered. Report any shortage to the place of purchase or to the nearest Fluke Service Center.

2-3. Reshipping the 6100A

A 'transit' case intended for accompanied transit can be purchased from Fluke. The Fluke part number is 1887580. This container is suitable for most handling conditions but provides less shock protection than the original cardboard packaging. It is recommended that the original container be used when possible.

2-4. Placement and Rack Mounting

This equipment is designed to operate in a controlled electromagnetic environment such as calibration and measurement laboratories i.e. where R.F. transmitters such as mobile telephones are not be used in close proximity.

The 6100A and 6101A units are suitable for benchtop use, so long as there is sufficient space either side (minimum 4 inches (100 mm) per side) to allow adequate ventilation.

The 6100A and 6101A units can be rack mounted using Fluke part number 1887571. Details of the rack mounting kit and fitting instructions are provided with the kit. Note that the airflow through the 6100A is from left to right as viewed from the front. If 6100A is mounted in a rack the airflow must be in the same direction.

2-5. Cooling Considerations

⚠ Caution

Damage caused by overheating may occur if the area around the air intake is restricted, the intake air is too warm, or the air filter becomes clogged.

The 6100A Electrical Power Standard must be at least 4 inches from nearby walls or rack enclosures on both sides.

The inlet and exhaust perforations on the sides of the 6100A Electrical Power Standard must be clear of obstruction.

The air entering the instrument must be between 5 C and 35 C. Make sure that exhaust from another instrument is not directed into the fan inlet.

Clean the air filter every 30 days or more frequently if the 6100A Electrical Power Standard is operated in a dusty environment. (Instructions for cleaning the air filter are in Chapter 6)

2-6. Line Voltage

The 6100A and 6101A Electrical Power Standards have automatic mains sensing in the range 100-240V, so no user line voltage selection is required. The fuse specified covers this voltage range. Chapter 6 describes fuse access.

2-7. Connecting to Line Power

⚠ WARNING

To avoid shock hazard, connect the factory supplied three-conductor line power cord to a properly grounded power outlet. Do not use a two-conductor adapter or extension cord; this will break the protective ground connection. If a two-conductor power cord must be used, a protective grounding wire must be connected between the ground terminal on the rear panel and ground before connecting the power cord or operating the instrument.

The power outlets supplying the 6100A/6100A system should be controlled by an emergency switch so that power can be switched off if a hazard arises.

The line current requirement of the 6100A Electrical Power Standard may exceed the capacity of standard 13 A IEC connectors so the unit is fitted with a 16 A power receptacle at the rear.

A suitable supply lead is provided. Ensure that the room supply outlet is suited to delivering the 1250VA maximum power requirements and that the 6100A Electrical Power Standard is connected to a properly grounded three-prong outlet. Note: typical maximum power requirement at 115V is 1000VA.

If a supply lead is provided WITHOUT a mains connector, please observe the following color coding when wiring up your own mains connector - line = brown, neutral = blue, earth =green/yellow.

Country	Fluke Line cord part number
UK	1998167
Europe	1998171
Australia, New Zealand, China	1998198
USA, Japan	1998209
Other (no plug fitted)	1998211

2-8. Connecting 6101A Auxiliary units

Each 6101A Auxiliary unit added to a 6100A Master provides an additional voltage and current phase. A 6100A Master can control up to three auxiliary units. The control connections are made by interconnection cable part number 2002080 supplied with each 6101A. The control connections are via connectors on 6100A and 6101A rear panels. Figure 2.1 shows the layout of connections on the 6100A.

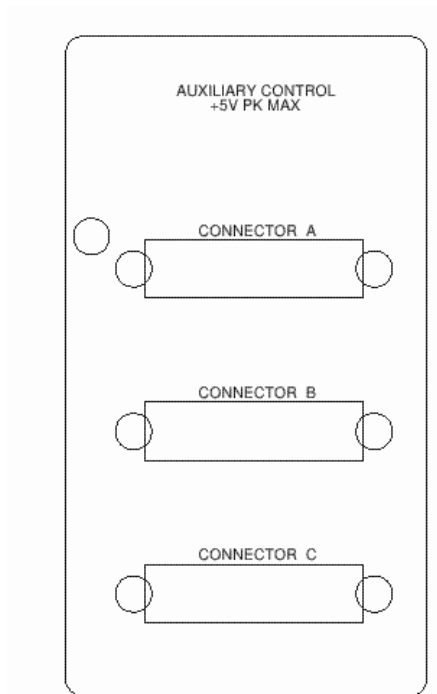

Figure 2-1. Auxiliary Unit connectors on the 6100A rear panel

2-9. Allocation of phases

The 6100A is always L1 in a multiphase system. 6101A Auxiliary units are allocated phase depending on which auxiliary control connector they are attached to. Connector A controls 'L2', the 6101A on connector B becomes 'L3' and that on connector C is designated as the 'N' phase. See chapter 3 for an overview of instrument control and the user interface.

Chapter 3

Features

	Title	Page
3-1.	Introduction	3-3
3-2.	Front Panel Features	3-3
3-3.	Windows™ User Interface	3-6
3-4.	The main graphical user interface areas.....	3-6
3-5.	Data entry from the front panel	3-7
3-6.	Data entry from an external keyboard and mouse	3-9
3-7.	Output channel selection.....	3-10
3-8.	Output control	3-10
3-9.	Rear Panel Features	3-11

3-1. Introduction

This chapter is a reference for the functions and locations of the 6100A Electrical Power Standard's front and rear panel features, and provides brief descriptions of each feature for quick access.

Please read this information before operating the Electrical Power Standard.

Front panel operating instructions for the Electrical Power Standard are provided in Chapter 4, and remote operating instructions are provided in Chapter 5.

3-2. Front Panel Features

Front panel features (including all controls, displays, indicators, and terminals) are shown in Figure 3-1. Each front panel feature is briefly described in Table 3-1.

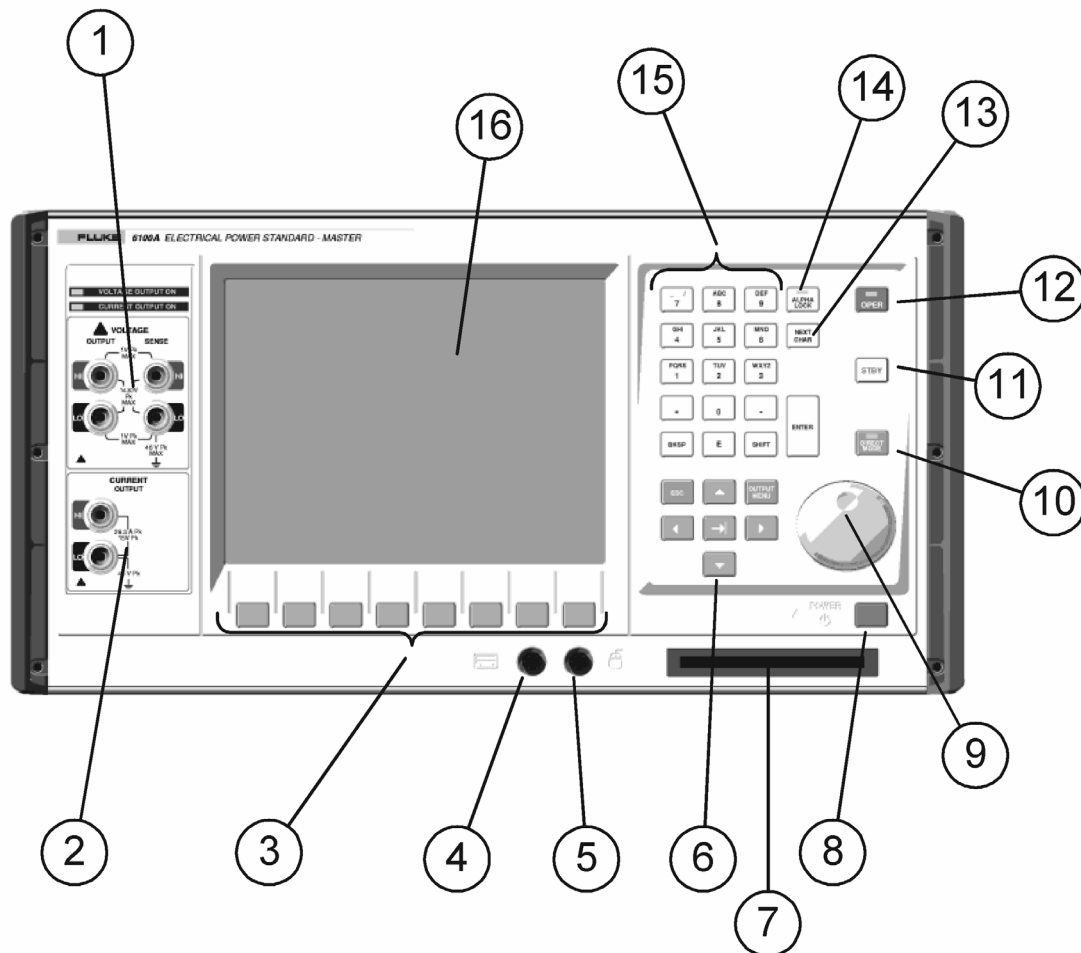

Figure 3-1. 6100A Front Panel

Table 3-1. Front Panel Features

1 Voltage Binding Posts	<p>The HI and LO Output Voltage Binding Posts provide connections for voltage outputs.</p> <p>The HI and LO Sense Binding Posts provide External Sensing for best accuracy. Two-wire sensing may be selected via the Global Settings Menu. See chapter 4</p>
2 Current Binding Posts	Currents are output from the Current Binding Posts.
3 Softkeys	The softkeys provide direct access to setup functions (see chapter 4). If an external keyboard is connected, the keyboard function keys (F1-F8) provide the same navigation technique.
4 Keyboard Connector	PS/2 connector for an external keyboard if preferred.
5 Mouse Connector	PS/2 connector for a mouse if preferred.
6 Navigation Keypad	<p>The SELECT MENU key switches between the three main 'menus': Output, Global settings and Waveform.</p> <p>The ESC (escape) key changes the softkey level up through the control hierarchy</p> <p>The central a TAB key moves focus from control to control within the selected 'menu' area.</p> <p>The left/right and up/down arrow keys allow selection of values in data entry and selection fields.</p>
7 Floppy Disk Drive	Allows saving and reloading of waveform configurations.
8 Power On/Off Switch	<p>Turns the power on and off. The switch remains locked inwards when the power is on. Pushing the switch again unlocks it and turns the power off.</p> <p>Note: this controls the power supply electronically and is not an isolation switch.</p>
9 Dual action 'spin' wheel	Provides quick data entry within a field. When rotated without pressing, scrolls the value of the currently highlighted numeric character in an input field. When rotated whilst pressed inwards, moves the cursor along the characters in the field.
10 DIRECT MODE key	In Direct Mode, the key LED is lit and all waveform changes take immediate effect. When Direct Mode is not active, the 6100A is in 'Deferred' mode. In Deferred mode changes to waveforms are stored but not applied. Stored changes can be applied simultaneously or 'undone'.
11 STBY (standby) key	Turns the output OFF.
12 OPER (operate) key	Turns the outputs of 'enabled' channels ON. The LED's above the terminals indicate which outputs are ON.

Table 3-1. Front Panel Features (continued)

13 NEXT CHAR key	In text input mode (Alpha Lock LED lit), key text using a combination of the NEXT CHAR key and the AlphaNumeric keypad (15). This operates much in the manner of a cell 'phone, allowing one alpha key to source more than one text character by being pressed repeatedly until the required character is displayed. Use the NEXT CHAR key to move onto the next position you wish to key. Press ENTER to finish the text entry.
14 ALPHA LOCK key	Switches between text and numeric input. In numeric input mode. The Alpha Lock light is out. In text input mode the Alpha Lock light is lit.
15 AlphaNumeric Keypad	Provides text and numeric input. Use the ALPHA LOCK key (14) to switch between numeric and text input. In numeric input mode (Alpha Lock light out), key numeric values directly (the E key allows exponents to be entered). In text input mode (Alpha Lock light lit), key text using a combination of the AlphaNumeric keypad and the NEXT CHAR key (13). This operates much in the manner of a cell 'phone, allowing one alpha key to source more than one text character.
16 Windows User Interface	The setup of waveforms and other functions of the Electrical Power Standard has been implemented as a Windows program. Chapter 4 contains these operational procedures.

3-3. Windows™ User Interface

The user interface of the Electrical Power Standard has been implemented as a Windows program. This chapter gives a broad outline of the user interface. Chapter 4 contains detailed operational procedures.

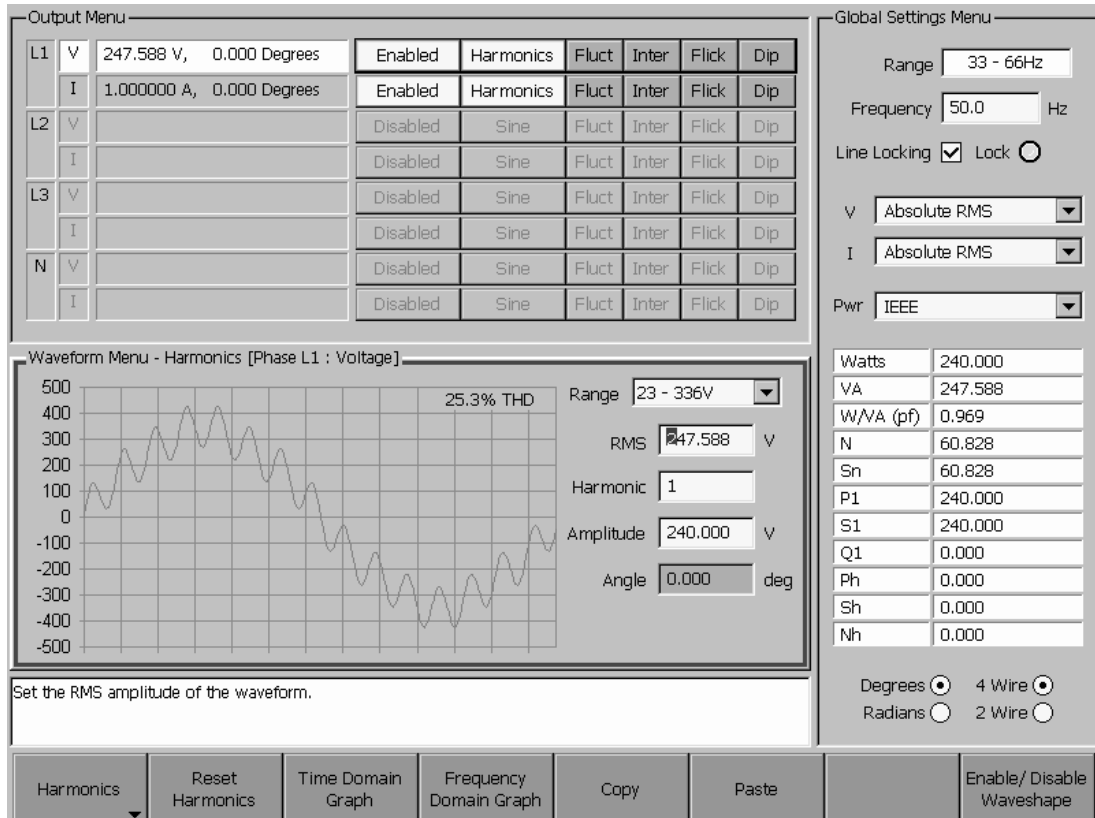

Figure 3-2. Graphical user interface

3-4. The main graphical user interface areas

The user interface is divided into 5 different areas. The three ‘menu’ areas provide user input fields

The Global Settings Menu provides settings that are applied to the 6100A and all 6101A auxiliaries connected to it.

The Output Menu provides part of the output control system and selection of the ‘phase’ and ‘channel’ (voltage or current) to be set up. The Output Menu always shows the actual values that are at the voltage and current binding posts (or will be when OPER is pressed).

The Waveform Menu is the area where the waveform for a channel is constructed. This part of the user interface shows what will be output when the settings are ‘Enabled’

Under the Waveform Menu is the message window which provides context sensitive help and error messages. The window background changes from white to red when an error message is displayed.

Eight ‘Soft keys’ which act with the selected ‘menu’ appear across the bottom of the screen.

In addition there are five ‘pop-up’ screens to load a previous set-up, to save the current set-up, to set date and time, to alter GPIB settings and an ‘about’ screen giving details of the GUI and embedded software. These ‘pop-ups’ are accessed from the Global Menu and More Settings soft key.

3-5. Data entry from the front panel

The principal navigation keys are:

The SELECT MENU key	This key moves the focus around the three main ‘menu’ panes. The pane with focus has a blue outline.
The softkeys	Context dependent softkeys at the bottom of the screen.
The ESC (escape) key	Moves upwards in the hierarchy of softkey level ‘Escapes’ from popup dialog boxes Removes warning and error messages.
The TAB key (center of the navigation keypad)	Moves the focus from control to control within the active ‘menu’ pane.
Up/down and left/right arrow keys	Assist selection and modification of values in data entry and selection fields
The ENTER key	Completes entry of data from the alphaNumeric keypad.

In Direct Mode all waveform changes take immediate effect. When the Direct Mode is not active, a number of changes can be made, stored and then applied simultaneously. Use the DIRECT MODE key to toggle between these options. The DIRECT MODE key is lit when in Direct Mode.

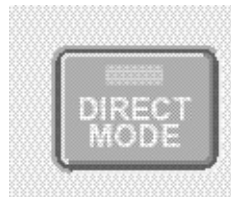

Figure 3-3. Direct Mode key

When in deferred mode, modifications of fields that affect the output waveform are notified by an orange background color. To activate the changes, select the softkey "Apply All" (visible when Output Menu is highlighted). Alternatively, if the output is on, press the OPER key to invoke the changes.

To undo deferred actions select “Undo all” from the Output menu. Selection of Direct Mode without applying the changes as described will also undo deferred actions.

Navigating to a screen data ‘field’ or pop-down ‘combo’.

Use the SELECT MENU key to move around the three menus on the page. When the required menu is highlighted (blue outline), use the TAB key to reach the field you require

OR

Use the softkeys that correspond to the required fields

Selecting values from a pop-down 'combo'

Once the 'combo' is highlighted, use the Up/Down or Left/Right keys to scroll through to find the required value

Changing values in a data field

Enter values directly from the alphanumeric keypad. The field changes color to an orange background while you are entering the new value. You must press the ENTER key or the TAB key to finish the data entry. (The orange background is retained in deferred mode operation).

OR

Use the 'navigation' keys to 'scroll' the value to the required number. Use the left and right arrow keys to select the column of the current value and the up and down arrow keys to change the value. For example, to change 123 to 163, first use the left and right keys until the 2 is highlighted, then use the up key (4 times) to set it to the required value. There is no need to press ENTER when the 'scroll' method is used.

The dual action spin wheel offers similar control; when depressed, the cursor is moved left and right; when not depressed the selected digit is incremented/decremented.

3-6. Data entry from an external keyboard and mouse

Navigating to a screen ‘field’. Either:

Point to the required ‘active’ data entry field and click the left mouse key to select it.

OR

Select the required ‘menu’ with the F9 key and then ‘tab’ to the required field using the Tab keys

Selecting from a pop-down ‘combo’

Once the ‘combo’ is highlighted, use the up and down arrow keys to scroll to the required value

Changing values in a data field

Enter values directly from the keyboard. The field changes color to orange background while you are entering the new value. You must press the Enter key or Tab key to finish the data entry

OR

Use the keyboard up, down, left and right arrow keys to ‘scroll’ the value to the required number. Use the left and right arrow keys to select the column of the current value and the up and down arrow keys to change the value. For example to change 123 to 163, first use the left and right keys until the 2 is highlighted, then use the up key (4 times) to set it to the required value. There is no need to press ENTER when the ‘scroll’ method is used.

Selecting check boxes and radio buttons

To toggle the selected check boxes press the space bar. To change the highlighted radio button use the cursor keys.

3-7. Output channel selection

Output Menu									
L1	V	11.0000 V, 0.000 Degrees	Disabled	Sine	Fluct	Inter	Flick	Dip	
	I	0.500000 A, 0.000 Degrees	Enabled	Harmonics	Fluct	Inter	Flick	Dip	
L2	V	110.000 V, 0.000 Degrees	Disabled	Sine	Fluct	Inter	Flick	Dip	
	I	0.500000 A, 0.000 Degrees	Disabled	Sine	Fluct	Inter	Flick	Dip	
L3	V	110.000 V, 0.000 Degrees	Disabled	Sine	Fluct	Inter	Flick	Dip	
	I	0.500000 A, 0.000 Degrees	Disabled	Sine	Fluct	Inter	Flick	Dip	
N	V		Channel	Sine	Fluct	Inter	Flick	Dip	
	I		Channel	Sine	Fluct	Inter	Flick	Dip	

Figure 3-4. The Output Menu

The Output Menu provides part of the output control system and selection of the ‘phase’ and ‘channel’ (voltage or current) to be set up. This menu is selected via the SELECT MENU key (or F9 on an external keyboard).

shows that the 6100A has two 6101A connected, one to 6100A connector A (L2), the other to connector B (L3).

3-8. Output control

The Enable/Disable softkeys that appear when the Output Menu is highlighted enable/disable particular waveshapes in the output. You can also use the TAB key and up and down arrow keys to move between fields. ENTER toggles the state of the button i.e., enables or disables the waveshape.

Enable/Disable Channel	Sine or Harmonics	Enable/Disable Fluct Harmonics	Enable/Disable Interharmonics	Enable/Disable Flicker	Enable/Disable Dip		
------------------------	-------------------	--------------------------------	-------------------------------	------------------------	--------------------	--	--

Figure 3-5. Output Menu softkeys

Voltages and currents can only appear at the output binding posts if the relevant channel is ‘enabled’ and the OPER key has been pressed. Pressing OPER turns on all ‘enabled’ channels. Note that pressing the OPER key when no voltage or current channels are enabled causes an error message to appear in the message window.

3-9. Rear Panel Features

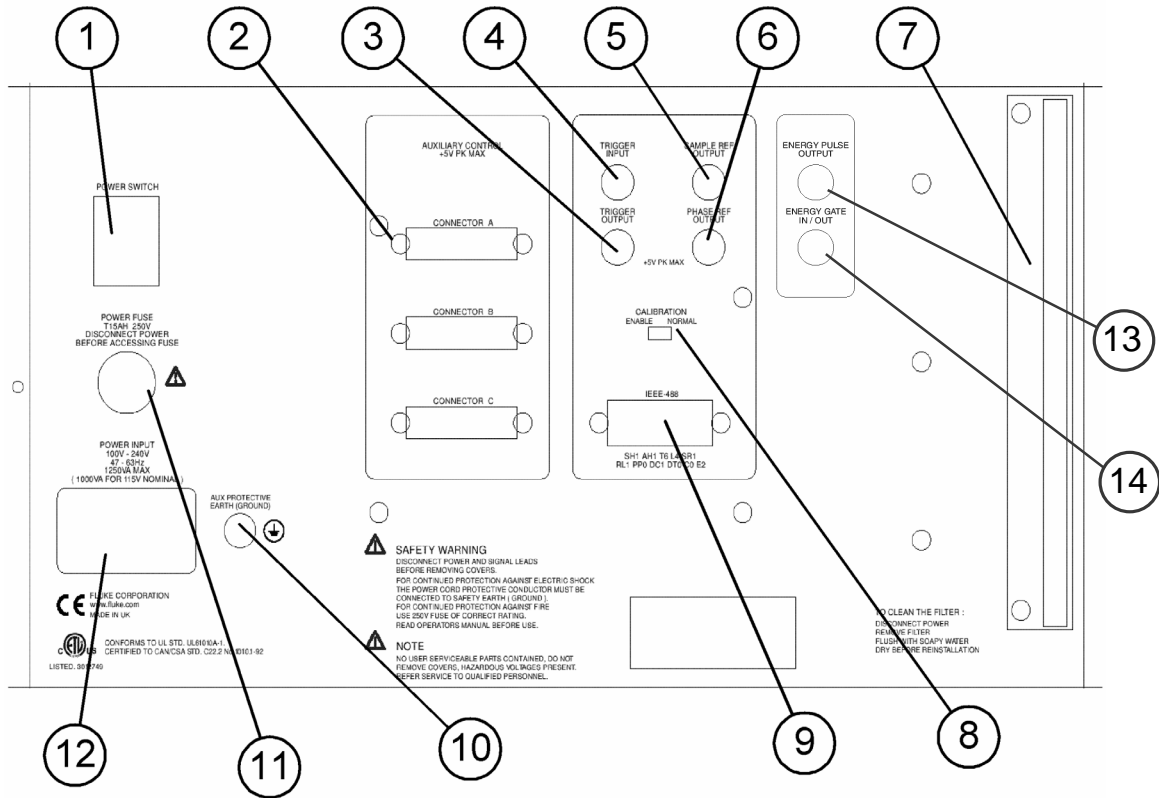

Figure 3-6. Rear Panel Features

Table 3-2. Rear Panel Features

1 Main power On-Off Switch	This is a true mains isolating switch.
2 Auxiliary Unit Connectors	Connection to Auxiliary units via Fluke supplied cable.
3 Trigger Out Connector	The Trigger Output Connector has a +5V CMOS logic drive providing a falling edge time marker intended to synchronize external equipment to the dip/swell function. The point at which the falling edge occurs is controlled by the Trigger Output Delay. After the falling edge the signal will remain low for a minimum of 10us.
4 Trigger Input Connector	The Trigger Input Connector is a TTL compatible input which can be selected to initiate a dip/swell on a falling edge. The falling edge can either start the user programmable initial delay timer or arms the user settable output waveform phase angle comparator. These are mutually exclusive. When the timer delay has expired or the comparator has found the required angle of the output waveform the Ramp In section of the dip/swell will commence. The input must remain low for 10us after the falling edge to be recognized properly.
5 Sample Ref Output Connector	The Sample Ref Output Connector has a +5V CMOS logic drive providing a falling edge intended to drive sampling measuring instruments synchronously with the internal sampling of the 6100A. The GPIB can enable and disable this signal. When it enables it the first falling edge will be delayed until the rising zero crossing of the L1 voltage fundamental. The signal will then continue until the GPIB disables it.
6 Phase Ref Output Connector	The Phase Reference Output Connector has a +5V CMOS logic drive providing a rising edge synchronous to the rising zero crossing of the L1 fundamental voltage. This signal has a 50% duty.
7 Air Filter	See Chapter 6 for air filter maintenance procedure.
8 Calibration Enable Switch	
9 IEEE 488 Connector	For connection to a GPIB system.
10 Ground Binding Post	Auxiliary protective earth/ground connection stud.
11 Fuse	See Chapter 6 for fuse replacement procedure.
12 Mains Power Receptacle	16A mains connector.
13 Energy Pulse Out connector (if fitted)	When the Energy option is fitted, the Energy pulse output provides pulses proportional to output power. See chapter eight for specifications and description. Blanked if the Energy option is not fitted.
14 Energy Gate In/Out connector (if fitted)	A bidirectional input or output gate control used with the Energy option. See chapter eight for specifications and description. Blanked if the Energy option is not fitted.

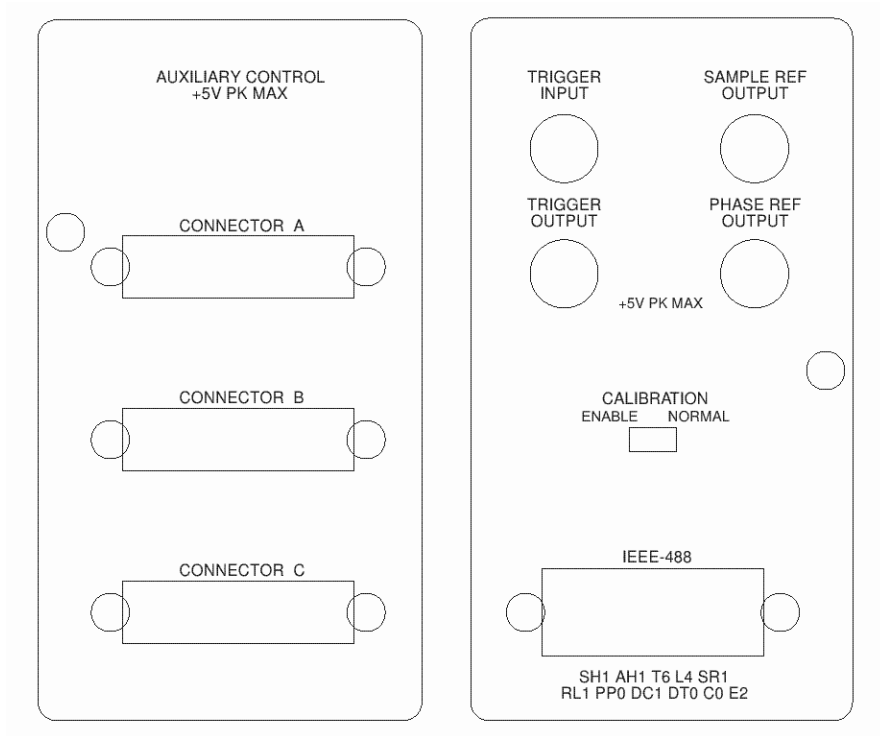

Figure 3-7. Rear Panel Connections

Chapter 4

Front Panel Operation

	Title	Page
4-1.	Introduction	4-3
4-2.	Power up.....	4-3
4-3.	Warm up	4-3
4-4.	Basic Setup Procedures	4-4
4-5.	Global settings	4-5
4-6.	Frequency	4-5
4-7.	Line locking	4-5
4-8.	Harmonic edit mode.....	4-5
4-9.	Reactive power calculation	4-6
4-10.	Phase units.....	4-6
4-11.	Voltage output 4-wire or 2-wire connection	4-6
4-12.	More Settings	4-7
4-13.	Edit mode.....	4-7
4-14.	Direct Mode	4-7
4-15.	Deferred mode.....	4-7
4-16.	Changes that are not deferred.....	4-8
4-17.	Setting up voltage and current waveforms	4-8
4-18.	Harmonics, DC and Sine	4-9
4-19.	Definition	4-9
4-20.	Access to this function	4-9
4-21.	6100A Specification.....	4-9
4-22.	Sine/harmonic mode.....	4-9
4-23.	Setting up harmonics and DC	4-11
4-24.	Interharmonics	4-12
4-25.	Definition	4-12
4-26.	Access to this function	4-12
4-27.	6100A Specification.....	4-12
4-28.	Setting up Interharmonics	4-12
4-29.	Fluctuating harmonics	4-13
4-30.	Definition	4-13
4-31.	Access to this function	4-13
4-32.	6100A Specification.....	4-13
4-33.	Setting up Fluctuating Harmonics.....	4-14
4-34.	Dips and Swells	4-14

4-35.	Definition	4-14
4-36.	Access to this function	4-15
4-37.	6100A Specification.....	4-15
4-38.	Setting up Dips/swells.....	4-16
4-39.	Flicker.....	4-18
4-40.	Definition	4-18
4-41.	Access to this function	4-18
4-42.	6100A Specification.....	4-18
4-43.	Setting up Flicker	4-19
4-44.	Copy and Paste	4-19
4-45.	Copy	4-19
4-46.	Paste	4-19

4-1. Introduction

This chapter provides instructions for operating the 6100A Electrical Power Standard from the front panel, which includes all aspects of setting up and configuring the 6100A Electrical Power Standard.

Before you begin following the procedures in this chapter, you should be familiar with the front panel controls, displays, and terminals, which are identified and described in detail in Chapter 3. For information on using remote commands to operate the 6100A Electrical Power Standard, refer to Chapter 5.

⚠ WARNING

The 6100A Electrical Power Standard is capable of supplying lethal voltages. Do not make connections to the output terminals when any voltage is present. Placing the instrument in standby may not be enough to avoid shock hazard. Disconnect the GPIB cable from 6100A to avoid remote commands setting unexpected outputs.

4-2. Power up

⚠ WARNING

To avoid electric shock, make sure the 6100A Electrical Power Standard is grounded as described in Chapter 2.

4-3. Warm up

The 6100A Electrical Power Standard must be allowed to warm up to ensure it meets the specifications listed in Chapter 1. Warm up periods are described in the specifications in Chapter 1.

4-4. Basic Setup Procedures

Refer to Chapter 3 for an explanation of how to ‘navigate’ about the Windows user interface and how to set up text and numeric values.

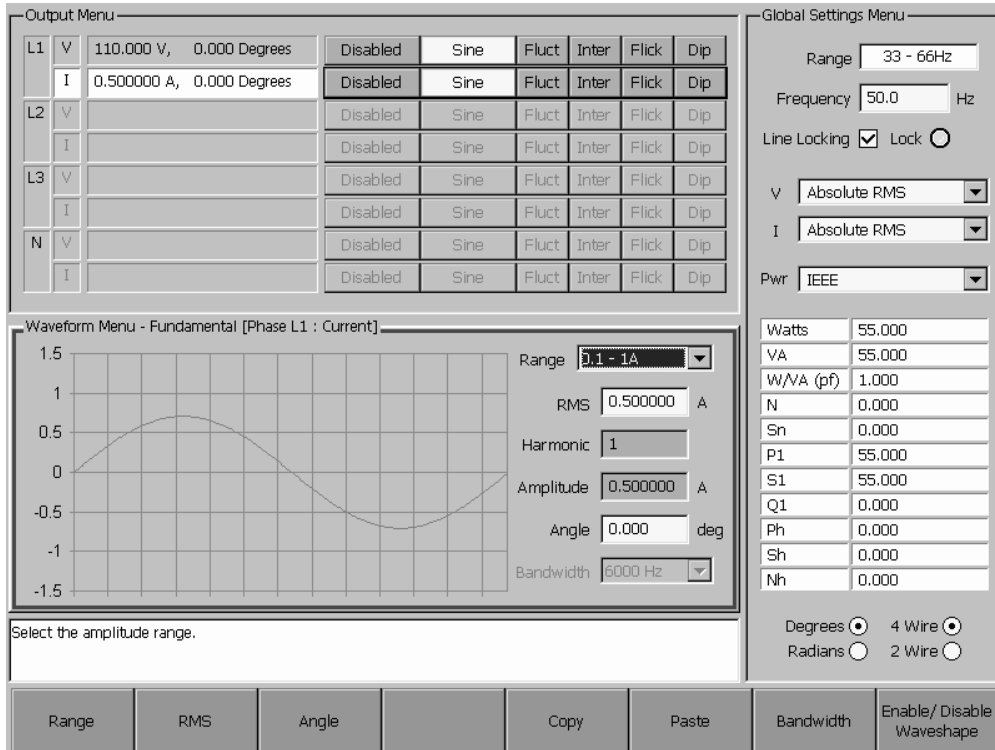

Figure 4-1. Main Setup Page

When the 6100A start-up sequence is complete, the instrument's main setup page is displayed.

This page contains the Output Menu at the top left. Below the Output Menu is the Waveform Menu whose content will change depending on the waveform parameter that is being edited.

To the right is the Global Settings Menu. Navigate between the menus using the SELECT MENU key.

4-5. Global settings

Navigate to the Global Settings Menu using the SELECT MENU key.



Figure 4-2. Global menu softkeys

4-6. Frequency

Set the required output frequency. An attempt to set frequency outside the active band when any output is ON will cause an error message to be displayed.

4-7. Line locking

It is essential for correct operation of 6100A that line locking is not selected unless the selected frequency is the same as the nominal input line frequency. Select line locking by checking the line lock box. The Lock indication shows green when the system is locked to line frequency. Red indicates that the 6100A has not locked to line frequency.

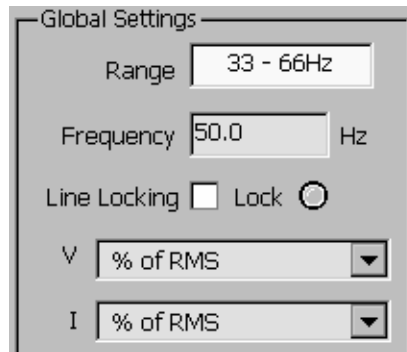

Figure 4-3. Frequency, Line Locking

4-8. Harmonic edit mode

Select the way voltage and current harmonics are entered. The available modes are as follows.

Harmonics entered as % of RMS value. Here the RMS value is maintained constant by reducing the level of the fundamental frequency component as harmonics are added. Changing the RMS value alters each harmonic accordingly.

Harmonics entered as % of the fundamental (first harmonic) value. Here the fundamental value is constant and the RMS value changes as harmonics are added. *Note that an error message will be generated if the peak value of the waveform exceeds the range maximum.* Changing the fundamental value alters all harmonics accordingly.

Harmonics entered as dB down value from the fundamental value. This mode acts in the same way as % of fundamental. *Note that 0dB is an invalid entry as it exceeds the 30% limit for harmonics.* The maximum value for a harmonic is -10.5dB

Harmonics entered as absolute RMS values. The RMS value of the output waveform increases as harmonics are added. *Note that an error message will be generated if the peak value of the waveform exceeds the range maximum.*

4-9. Reactive power calculation

Navigate to the Global Settings Menu using the SELECT MENU key.

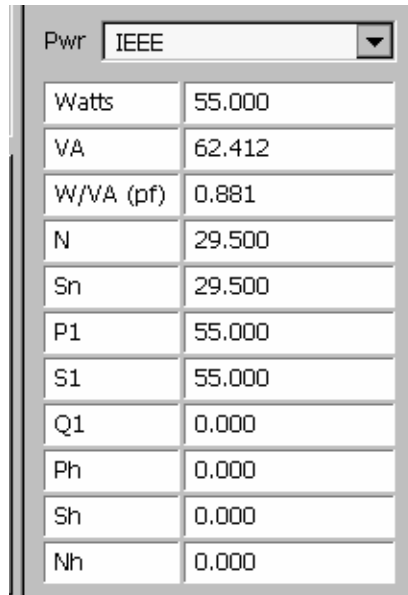

Pwr	IEEE
Watts	55.000
VA	62.412
W/VA (pf)	0.881
N	29.500
Sn	29.500
P1	55.000
S1	55.000
Q1	0.000
Ph	0.000
Sh	0.000
Nh	0.000

Figure 4-4. Reactive power calculation

Select the reactive power calculation method most suitable for your purpose from Budeanu, Fryze, Kusters & Moore, Shepherd & Zakikhani, Sharon/Czarnecki or IEEE.

4-10. Phase units

Select the Phase Units softkey and select degrees or radians. Press ESC to return to the previous soft key level.

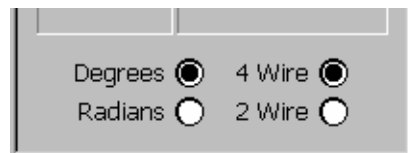

Figure 4-5. Global Settings Menu

4-11. Voltage output 4-wire or 2-wire connection

⚠ WARNING

The sense wires and voltage binding posts are at output potential even when 2-wire is selected.

Select the Terminals softkey and select 2 wire or 4-wire connection. *Note that full accuracy is only available with a 4-wire connecting lead and 4-wire selected.* Press ESC to return to the previous soft key level.



Figure 4-6. 4-wire/2-wire selection

The lead kit provided includes a voltage lead that can be used for 2-wire or 4-wire connection. The brown wire connects to SENSE-HI, blue to SENSE-LO, red to OUTPUT-HI and black to OUTPUT-LO.

4-12. More Settings

The More Settings softkey provides access to five 'pop-up' screens and a softkey that allows the instrument to be reset to the factory default settings.

When the Save setup softkey is pressed, internal memory and the floppy disk drive are searched for setup files. Previous setups can be copied to internal memory or floppy disk and renamed or deleted. The name of the file where the current setup is to be stored can be edited by selecting the File Name softkey and using the keyboard alphanumeric keys. Press the Save softkey to store the current 'system' setup.

Select Load Set-up and a configuration stored previously can be loaded from internal memory or floppy disk.

Note: settings are those of the entire system so one three phase setup can be transferred to another three-phase system. Where the saving and loading configurations differ, only settings appropriate to the loading system are transferred. If for example the settings of a three-phase system are loaded onto a single-phase system, only the settings for the 6100A are loaded.

The 6100A date and time settings are altered via the Set Date and Time softkey.

The GPIB settings softkey allows Bus address, Event Status Enable (ESE) and Status Register Enable (SRE) and the Power On Status Clear (PON) values to be set.

The About screen giving details of the GUI and embedded software and which if any options are fitted.

4-13. Edit mode

The DIRECT MODE key controls edit mode.

4-14. Direct Mode

In Direct Mode, the DIRECT MODE key LED is lit. All waveform changes take immediate effect.

4-15. Deferred mode

When the DIRECT MODE LED is not lit, the 6100A is in Deferred Mode. In this mode, changes made are stored for later invocation. When in deferred mode, if the output for the channel being modified is ON, modification to fields that affect the output waveform are notified by an orange background color.

Note: operations which are invalid when the output is ON are also invalid when Deferred mode is active, even if the output is OFF. For example you cannot change range in Deferred mode even if the output is OFF

To activate deferred mode changes:

select the Output Menu softkey 'Apply All' or,

if the output is already ON, press the OPER (operate) key.

The following actions undo all pending changes:

press the softkey 'Undo All',

press STBY or,
press the DIRECT MODE key (edit mode changes to Direct).

4-16. Changes that are not deferred

In deferred mode, changes to all fields are deferred with the following exceptions.

Line Locking.

Change of harmonic edit mode (e.g. Absolute RMS, % of RMS etc).

Power calculation method.

Selection of Phase Units (Degrees/Radians).

Selection of 2 Wire/4 Wire because terminal configuration cannot be changed when the output is on.

Global settings Time/Date and GPIB settings cannot be changed in deferred mode.

Load/Save setup is not available in deferred mode

Note: Entry into calibration mode automatically selects Direct Mode.

4-17. Setting up voltage and current waveforms

The following describes setting up voltage waveforms but applies equally to current.

Navigate to the Output Menu and use the cursor up/down keys until the voltage or current channel to be set up is highlighted.

Output Menu									
L1	V	110.000 V, 0.000 Degrees	Disabled	Sine	Fluct	Inter	Flick	Dip	
	I	0.500000 A, 0.000 Degrees	Disabled	Sine	Fluct	Inter	Flick	Dip	
L2	V	110.000 V, -120.000 Degrees	Disabled	Sine	Fluct	Inter	Flick	Dip	
	I	0.500000 A, 0.000 Degrees	Disabled	Sine	Fluct	Inter	Flick	Dip	
L3	V	110.000 V, 120.000 Degrees	Disabled	Sine	Fluct	Inter	Flick	Dip	
	I	0.500000 A, 0.000 Degrees	Disabled	Sine	Fluct	Inter	Flick	Dip	
N	V		Channel	Sine	Fluct	Inter	Flick	Dip	
	I		Channel	Sine	Fluct	Inter	Flick	Dip	

Figure 4-7. Channel selection

Note: a channel must be ‘enabled’ and the OPER key pressed for an output to appear at the binding posts. If the output is already on but the active channel is not enabled, pressing the Enable/Disable Channel softkey will cause the output to appear at the relevant binding posts.

Navigate to the Waveform Menu with the SELECT MENU key. If necessary press ESC until the top level softkeys are shown (Figure 4-8). Select Edit Harmonics, Fluctuating Harmonics, Interharmonics Flicker or Dip by pressing the appropriate softkey.

Harmonics	Reset Harmonics	Time Domain Graph	Frequency Domain Graph	Copy	Paste	Enable/Disable Waveshape
-----------	-----------------	-------------------	------------------------	------	-------	--------------------------

Figure 4-8. Waveform top level

4-18. Harmonics, DC and Sine

4-19. Definition

A Harmonic is an integer multiple of the fundamental frequency. In the 6100 harmonic number 1 is the the fundamental frequency. DC is denoted by harmonic 0.

4-20. Access to this function

Use the SELECT MENU key to navigate to the Waveform Menu and select Edit Harmonics from the softkeys.

4-21. 6100A Specification

Harmonics	2 nd to 100th up to 6 kHz
Simultaneous Harmonics	99 (excluding DC and the 1st)
Max. Amplitude of a Single Harmonic	The maximum value for a harmonic < 2850Hz is 30% of range. (See Chapter 1, 1-8 for the profile above 2850Hz)
Current channel bandwidth setting	1.5kHz or 6kHz (1.5kHz or 3kHz for 80A option if fitted)

Note that selecting the lower bandwidth setting reduces the number of harmonics that can be set but increases inductive drive capability (see Chapter 1, paragraph 1-22).

4-22. Sine/harmonic mode

Pressing the Enable/Disable Waveshape softkey toggles between Sine and Harmonics mode.

Note that the Output Menu will show either “Sine” or “Harmonic”.

In Sine mode only, Range, RMS and Angle fields can be edited. The one exception is the voltage channel of L1 where the phase angle is fixed at 0.000 degrees. Select the required entry field using the softkeys or TAB key.

DC is not available in Sine mode.

Figure 4.9 below shows the Harmonic mode with time domain waveform selected. In figure 4.10, frequency domain graph is selected.

Note that Figure 4.7 shows the L1 voltage channel in ‘sine’ mode. Figures 4.9 and 4.10 show L1 voltage in Harmonics mode.

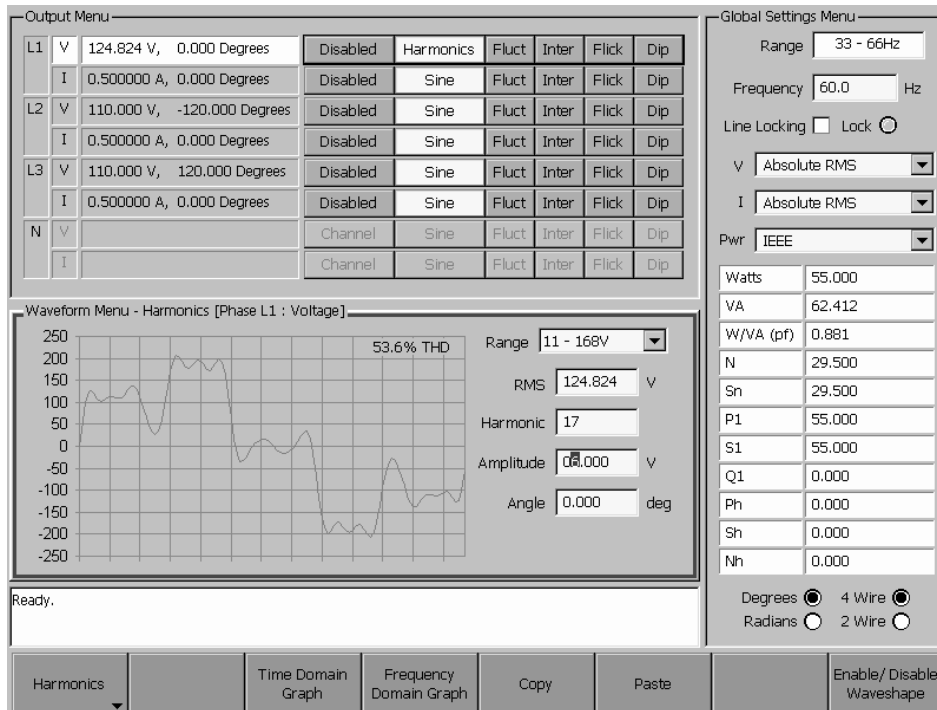

Figure 4-9. Harmonics with time domain graph

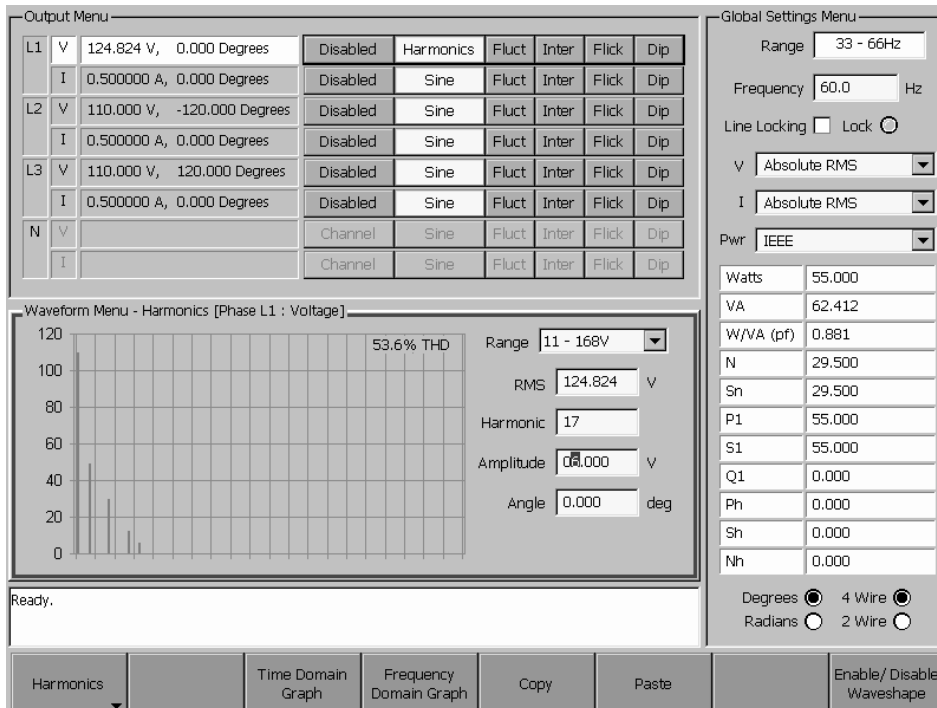

Figure 4-10. Harmonics with frequency domain graph

4-23. Setting up harmonics and DC

If the Global Settings are set to "percentage of RMS value", the fundamental amplitude is automatically adjusted as harmonics are added, in order to maintain the RMS value constant. The fundamental amplitude cannot be altered.

To add a harmonic, change the value in the Harmonic field to the required number. A harmonic number of 0 represents a DC component.

The default amplitude will appear as 0%, - 200 dB or 0 V (or 0 A). The default phase angle for harmonics is 0 degrees or 0 radians.

Each time the value in the Harmonic field is changed and its amplitude is set to a non-zero value, a new harmonic is added to the waveshape and displayed in the graph. Harmonics do not appear at the output unless Harmonics mode is enabled for that channel.

Review the selections via the Previous Harmonic and Next Harmonic softkeys.

The Reset Harmonics softkey removes all harmonics from the active channel (see Figure 4-11)

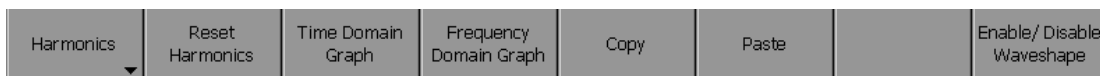

Figure 4-11. Softkeys for Harmonics top level



Figure 4-12. Softkeys for Harmonics second level

To remove a single harmonic from the set-up, set its amplitude to 0% or use the Remove Harmonic softkey (see Figure 4-12).

Use the Enable/Disable Waveshape softkey to revert to the fundamental, leaving the harmonics available for re-application. The graph display retains the combined waveshape. (Change between Sine and Harmonics mode is also available from the Output Menu softkeys).

4-24. Interharmonics

4-25. Definition

A frequency component of a periodic quantity (AC waveform) that is not an integer multiple of the frequency at which the system is operating (e.g., if the fundamental frequency is 60Hz, an 83Hz component in the waveform is an interharmonic).

4-26. Access to this function

Use the SELECT MENU key to navigate to the Waveform Menu and select Edit Interharmonics from the Softkeys

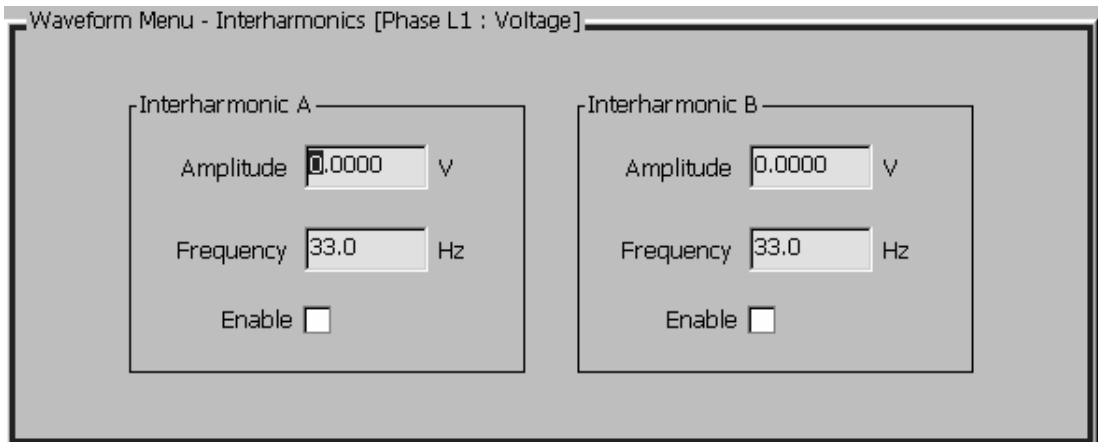

Figure 4-13. Waveform Menu for Interharmonics

4-27. 6100A Specification

Frequency accuracy	50ppm
Amplitude accuracy 16Hz to < 6kHz	1%
Amplitude accuracy > 6kHz	4%
Maximum value of a single interharmonic	The maximum value for an interharmonic < 2850Hz is 30% of range. (See Chapter 1, 1-8 for the profile above 2850Hz)
Frequency range of interharmonic	16Hz to 9kHz

4-28. Setting up Interharmonics

Two interharmonic phenomena can be applied simultaneously.

Set the required amplitude and frequency of each and enable them with the check box. Values entered outside the specified range result in an error message.



Figure 4-14. Softkeys for Interharmonics

Use the 'Enable/Disable Waveshape' softkey to turn this function on or off from the Waveform Menu. Alternatively use the 'Enable/Disable Interharmonics' softkey in the Output menu.

4-29. Fluctuating harmonics

4-30. Definition

Fluctuating harmonics are those that maintain their fixed harmonic relationship with the fundamental, but vary in amplitude over time. If all components of a waveform vary in amplitude over time, this is equivalent to Flicker.

4-31. Access to this function

Use the SELECT MENU key to navigate to the Waveform Menu and select Edit Fluct Harmonics from the Softkeys

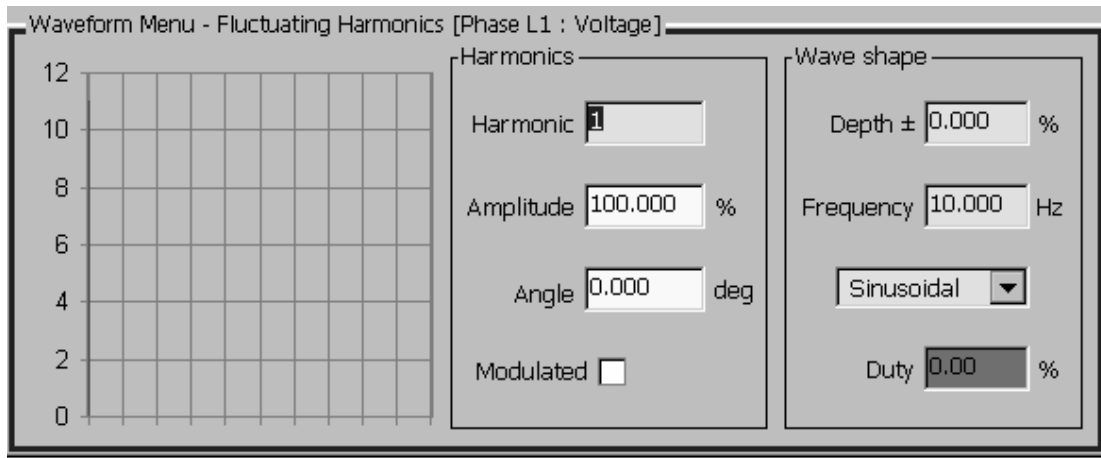

Figure 4-15. Waveform Menu for Fluctuating Harmonics

4-32. 6100A Specification

Number of harmonics to fluctuate	Any number from 0 to all set harmonics can fluctuate
Modulation depth setting range [1]	0% to 100% of nominal harmonic voltage
Fluctuation accuracy (0% to ± 30% modulation)	0.025%
Modulation depth setting resolution	0.001%
Shape	Rectangular or Sinusoidal
Duty cycle (shape = rectangular)	0.1 % to 99.99 %
Modulating Frequency range	0.008Hz to 30Hz
Sine modulating frequency accuracy	50ppm ± 10 μHz
Rectangular modulating frequency accuracy	< 1300ppm [2]
Modulating Frequency setting resolution	0.001 Hz

4-33. **Setting up Fluctuating Harmonics**

It is only possible to set-up Fluctuating Harmonics properties for existing harmonics.

Select 'Edit Fluct Harmonics' from the Waveform Menu softkeys.



Figure 4-16. Softkeys for Fluctuating Harmonics

Select the harmonic to that fluctuation is to be applied to using the 'Previous Harmonic', 'Next Harmonic' or the 'Harmonic' softkeys. The 'Modulated' softkey toggles the 'modulated' check box.

The 'Waveshape' softkey provides access to a further softkey menu allowing control of depth, frequency and shape of the modulation.



Figure 4-17. Waveshape Softkeys

Use the 'Enable/Disable Waveshape' softkey to turn this function on or off from the Waveform Menu. Alternatively use the 'Enable/Disable Fluct Harmonics' softkey in the Output menu.

4-34. **Dips and Swells**

Dips/swells are primarily a voltage phenomenon but are also provided for current outputs in the 6100A.

4-35. **Definition**

A dip is a sudden decrease of voltage at a point in the electrical system, followed by voltage recovery after a short period of time, from half a cycle to a few tens of seconds. A swell is an increase.

When triggered externally, dip/swell events occur simultaneously on all channels that have dip enabled.

4-36. Access to this function

Use the SELECT MENU key to navigate to the Waveform Menu and select Edit Dip from the Softkeys

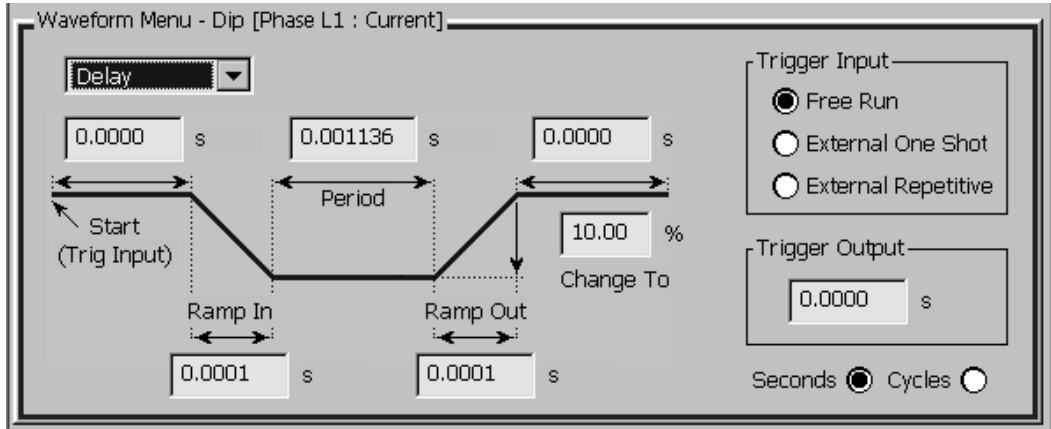

Figure 4-18. Waveform Menu for Dip

4-37. 6100A Specification

Trigger in requirement	TTL falling edge remaining low for 10us
Either: Trigger in delay OR Phase angle synchronization with respect to channel fundamental frequency zero crossing	0 to 60 seconds \pm 31 μ s \pm 180 $^\circ$ \pm 31 μ s
Dip/Swell Min duration	1 ms
Dip/Swell Max duration	1 minute
Dip Min amplitude	0% of the nominal output
Swell Max amplitude	The least of full range value and 140% of the nominal output
Ramp up/down period	Settable 100 μ s to 30 seconds
Optional repeat with delay	0 to 60 seconds \pm 31 μ s
Starting level amplitude accuracy	\pm 0.025% of level
Dip/Swell level amplitude accuracy [1]	\pm 0.25% of level
Trigger out delay	0 to 60 seconds \pm 31 μ s from start of dip/swell event
Trigger out	TTL falling edge co-incident with end of trigger out delay, remaining low for 10 μ s to 31 μ s

4-38. Setting up Dips/swells

The Dip waveform menu has two sections: Waveshape and Trigger.



Figure 4-19. Top level Dip softkeys

Waveshape parameters

The start of the dip/swell can be set to start after a delay (in seconds) or at a particular phase angle. All other parameters can be set in seconds or cycles.



Figure 4-20. Dip Waveshape softkeys

Start On Delay	Start a fixed time period after an external trigger.
Start on Phase Angle	Start determined by phase angle. <i>Note: to ensure all phases start simultaneously, this is the phase angle of the L1 phase irrespective of which phases dips are programmed on.</i>
Start Delay or Angle	Set selected value for delay or phase angle
Ramp in	Ramp in period
Period	Time at the Dip/swell 'change to' level
Ramp Out	Ramp out period
Change to	The value to dip to as a percentage of the starting level
End delay	Minimum end period before a re-trigger can occur

Trigger control



Figure 4-21. Dip Trigger softkeys

There are three trigger-input modes:

Free Running The dip/swell is triggered internally, is controlled by the set parameters and repeats indefinitely.

External One Shot The dip/swell is triggered once by external trigger applied to the TRIGGER INPUT connector on the 6100A rear panel. The trigger signal must be TTL compatible. The low going transition causes a trigger.

External Repetitive The dip/swell is triggered by a single external low going trigger applied to the TRIGGER INPUT connector and repeats in 'free running' mode until stopped by a change to any dip/swell parameter.

An output trigger is provided to control external equipment. This trigger appears on the TRIGGER OUTPUT connector on the rear of any 6100A or 6101A producing a dip or swell. The output trigger may be set to occur at the same time as the input trigger (0 seconds delay), or delayed by a time set in the Trigger Output control field. When either Free Running or External Repetitive trigger input mode is selected, the trigger output delay must be less than the total combined dip/swell event time for a trigger output signal to be generated.

Use the 'Enable/Disable Waveshape' softkey to turn this function on or off from the Waveform Menu. Alternatively use the 'Enable/Disable Dip' softkey in the Output menu.

4-39. Flicker

Flicker is primarily a voltage phenomenon but is also provided for current outputs in the 6100A.

4-40. Definition

Repetitive (voltage) level variation in the range to cause the physiological phenomenon of flicker. Flicker severity is described by perception level. This is either perception level for a short term called P_{ST} (nominally 10 minutes) or long term called P_{LT} . The P_{ST} value displayed by the 6100A is only valid for certain output settings. See the specification in chapter 1.

4-41. Access to this function

Use the SELECT MENU key to navigate to the Waveform Menu and select Edit Flicker from the Softkeys

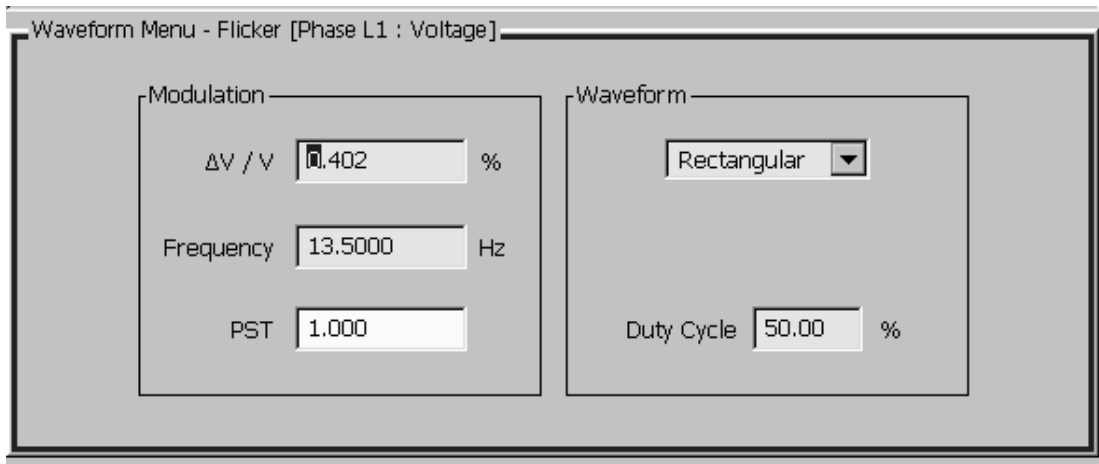

Figure 4-22. Flicker Menu

4-42. 6100A Specification

Setting range	$\pm 30\%$ of set value within range values (60% $\Delta V/V$)
Flicker modulation depth accuracy	0.025%
Modulation depth setting resolution	0.001%
Shape	Rectangular or Sinusoidal
Duty cycle (shape = rectangular)	0.01 % to 99.99 % $\pm 31\mu s$
Modulating Frequency range	0.0008Hz to 40Hz
Sine modulating frequency accuracy	50ppm $\pm 10 \mu Hz$
Square modulating frequency accuracy	50ppm $\pm 16 \mu s$
Modulating Frequency setting resolution	0.0001 Hz

4-43. Setting up Flicker

The Flicker ‘panel’ has two sections – Modulation and Waveform



Figure 4-23 Flicker Softkeys

Modulation

Depth	Up to +/- 30% of set voltage or current
Frequency	Flicker frequency

Waveform

Sinusoidal/Square/Rectangular	Flicker envelop type
Duty cycle	Shape of rectangular waveform

Use the ‘Enable/Disable Waveshape’ softkey to turn this function on or off from the Waveform Menu. Alternatively use the ‘Enable/Disable Flicker’ softkey in the Output menu.

4-44. Copy and Paste

Each of the Waveform menus has ‘Copy’ and ‘Paste’ softkeys at the top level.

4-45. Copy

Pressing ‘Copy’ puts a copy of the currently active Waveform Menu into the clipboard. There is only one clipboard and this is overwritten each time ‘Copy’ is pressed. The contents of the clipboard are lost when line power is turned off.

4-46. Paste

‘Paste’ allows setups to be copied from the clipboard onto another channel as long as the active Waveform Menu is of the same type. You cannot copy from a Current channel to a Voltage channel.

Pasting erases any existing data in the active Waveform menu.

The harmonics and fluctuation waveform menus share harmonic data, so pasting harmonic data will refresh the data used in the other, i.e., pasting Harmonic data into another channel will also paste the modulation settings.

Chapter 5

Remote Operation

	Title	Page
5-1.	Introduction	5-3
5-2.	Using the IEEE-488 Port for Remote Control	5-3
5-3.	Programming Options.....	5-3
5-4.	Capability Codes	5-4
5-5.	Bus Addresses	5-5
5-6.	Default bus address	5-5
5-7.	Limited Access	5-5
5-8.	Interconnections	5-5
5-9.	Operation via the IEEE 488 Interface.....	5-6
5-10.	General	5-6
5-11.	Operating Conditions	5-6
5-12.	Programmed Transfer to Local Control (GTL or REN False).....	5-6
5-13.	'Device Clear'	5-7
5-14.	Levels of Reset	5-7
5-15.	Message Exchange	5-8
5-16.	IEEE 488.2 Model.....	5-8
5-17.	Instrument STATUS Subsystem	5-8
5-18.	Incoming Commands and Queries	5-9
5-19.	Instrument Functions and Facilities	5-9
5-20.	Outgoing Responses	5-9
5-21.	'Query Error'	5-10
5-22.	Request Service (RQS)	5-10
5-23.	Reasons for Requesting Service	5-10
5-24.	RQS in the IEEE 488.2 Model.....	5-10
5-25.	Retrieval of Device Status Information.....	5-10
5-26.	General	5-10
5-27.	IEEE 488 and SCPI Standard defined Features	5-11
5-28.	Status Summary Information and SRQ.....	5-12
5-29.	Event Register Conditions	5-12
5-30.	Access via the Application Program.....	5-12
5-31.	Instrument Status Reporting IEEE 488.2 Basics	5-13
5-32.	IEEE 488.2 Model.....	5-13
5-33.	Instrument Model Structure	5-13
5-34.	Status Byte Register	5-13
5-35.	Reading the Status Byte Register.....	5-14
5-36.	Service Request Enable Register	5-14
5-37.	Reading the Service Request Enable Register	5-14

5-38.	IEEE 488.2 defined Event Status Register.....	5-14
5-39.	Standard Event Status Enable Register.....	5-16
5-40.	Reading the Standard Event Enable Register	5-17
5-41.	The Error Queue	5-17
5-42.	Instrument Status Reporting — SCPI Elements.....	5-17
5-43.	General	5-17
5-44.	SCPI Status Registers.....	5-17
5-45.	Reportable SCPI States	5-17
5-46.	SCPI Programming Language.....	5-18
5-47.	SCPI Commands and Syntax.....	5-19
5-48.	SCPI Command Summary.....	5-19
5-49.	Calibration Subsystem Command Details.....	5-25
5-50.	Output Subsystem Command Details	5-27
5-51.	Source Subsystem Command Details	5-28
5-52.	General Commands.....	5-28
5-53.	Power Values	5-29
5-54.	Voltage Setup.....	5-31
5-55.	DC and Harmonics Phenomenon.....	5-31
5-56.	Fluctuating Harmonics Phenomenon.....	5-33
5-57.	Interharmonics Phenomenon	5-34
5-58.	Dip Phenomenon.....	5-34
5-59.	Flicker Phenomenon	5-35
5-60.	Current Setup.....	5-36
5-61.	Harmonics Phenomenon	5-37
5-62.	Fluctuating Harmonics Phenomenon.....	5-39
5-63.	Interharmonics Phenomenon	5-40
5-64.	Dip Phenomenon.....	5-40
5-65.	Flicker Phenomenon	5-41
5-66.	Status Subsystem Command Details.....	5-42
5-67.	System Subsystem Command Details	5-43
5-68.	Unit Subsystem Command Details	5-44
5-69.	Common Commands and Queries	5-46
5-70.	Clear Status	5-46
5-71.	Event Status Enable.....	5-46
5-72.	Recall Event Status Enable	5-46
5-73.	Read Event Status Register	5-47
5-74.	*IDN? (Instrument Identification)	5-47
5-75.	Operation Complete	5-48
5-76.	Operation Complete?	5-48
5-77.	Recall the instrument Hardware Fitment	5-49
5-78.	Power On Status Clear	5-49
5-79.	Recall Power On Status Clear Flag.....	5-50
5-80.	Reset.....	5-51
5-81.	Service Request Enable.....	5-51
5-82.	Recall Service Request Enable	5-52
5-83.	Read Service Request Register	5-52
5-84.	Test Operations — Full Selftest.....	5-53
5-85.	Wait.....	5-53
5-86.	Device settings after *RST.....	5-54
5-87.	Introduction.....	5-54
5-88.	Device Settings at POWER ON	5-55
5-89.	General	5-55
5-90.	Power On Settings Related to Common IEEE 488.2 Commands	5-56
5-91.	*RST Settings Related to Common IEEE 488.2 Commands.....	5-57
5-92.	*RST Settings Related to SCPI Commands.....	5-58
5-93.	Worked examples	5-60

5-1. Introduction

The 6100A Electrical Power Standard is capable of operating under the remote control of an instrument controller, computer or terminal, as well as under the direct control from the front panel.

The 6101A Auxiliary units can also be controlled remotely. But, in this case the remote control connection is still made to the 6100A Electrical Power Standard, which in turn communicates with the Auxiliary units.

⚠ WARNING

The 6100A Electrical Power Standard is capable of supplying lethal voltages. Do not make or touch connections to the output binding posts while the 6100A is connected to the GPIB to avoid unexpected, dangerous settings.

5-2. Using the IEEE-488 Port for Remote Control

The 6100A Electrical Power Standard is fully programmable for use on the IEEE Standard 488.1 interface bus (IEEE-488 bus). The interface is also designed in compliance with supplemental standard IEEE-488.2. Devices connected to the bus in a system are designated as talkers, listeners, talker/listeners, or controllers. Under the remote control of an instrument controller, the 6100A Electrical Power Standard operates exclusively as a talker/listener on the IEEE-488 bus.

For more detailed information, refer to the standard specification in the publications ANSI/ IEEE Std. 488.1 - 1987 and IEEE Std. 488.2 - 1988.

The 6100A Electrical Power Standard conforms to the Standard Specification IEEE 488.1 - 1987: 'IEEE Standard Digital Interface for Programmable Instrumentation', and to IEEE 488.2 - 1988: 'Codes, Formats, Protocols and Common Commands'.

In IEEE 488.2 terminology the 6100A Electrical Power Standard is a **device** containing a **system interface**. It can be connected to a **system** via its **system bus** and set into programmed communication with other bus-connected **devices** under the direction of a system **controller**.

5-3. Programming Options

The 6100A Electrical Power Standard can be programmed via the IEEE Interface, to:

- Change its operating state (Function, Source, etc).
- Transmit its own status data over the bus.
- Request service from the system controller.

5-4. Capability Codes

- To conform to the IEEE 488.1 standard specification, it is not essential for a device to encompass the full range of bus capabilities.
- For IEEE 488.2, the device must conform exactly to a specific subset of IEEE 488.1, with a minimal choice of optional capabilities.

The IEEE 488.1 document describes and codes the standard bus features, for manufacturers to give brief coded descriptions of their own interfaces' overall capability.

For IEEE 488.2, this description is required to be part of the device documentation. A code string is often printed on the product itself.

The codes that apply to the 6100A Electrical Power Standard are given in the Figure 5-1 below, together with short descriptions.

They also appear on the rear of the 6100A Electrical Power Standard next to the interface connector. These codes conform to IEEE 488.2 requirements.

Appendix C of the IEEE 488.1 document contains a fuller description of each code.

IEEE 488.1 Interface Function Subset	
SH1	Source Handshake Capability
AH1	Acceptor Handshake Capability
T0	Talker (basic talker, serial poll, unaddressed to talk if addressed to listen)
L4	Listener (basic listener, unaddressed to listen if addressed to talk)
SR1	Service Request Capability
RL1	Remote/Local Capability (incl. Local Lockout)
PP0	No Parallel Poll Capability
DC1	Device Clear Capability
DT0	No Device Trigger Capability
C0	No Controller Capability
E2	Open-Collector and Three-State Drivers

IEEE 488.1 Interface Capability

Figure 5-1. IEEE 488 Compatibility Codes

5-5. Bus Addresses

When an IEEE 488 system comprises several instruments, a unique 'Address' is assigned to each to enable the controller to communicate with them individually.

The 6100A Electrical Power Standard has one primary address, which can be set by the user to an exclusive value within the range from 0 to 30 inclusive. It cannot be made to respond to any address outside this range. Secondary addressing is not available. The application program adds data to the active address, to define 'talk' or 'listen'.

5-6. Default bus address

The default setting is 18.

5-7. Limited Access

The 6100A Electrical Power Standard has three basic operating modes. Some of these modes only give limited support for remote control:

- **Manual Mode** - Remote operation is available for all of manual mode, but for ease of programming, some remote commands do not mirror front panel operations exactly.
- **Calibration Mode** - Remote operation is available.
- **Test Mode** - Remote operation is not available, but the 'Full' selftest can be initiated by a SCPI command. The 6100A Electrical Power Standard will give a straight Pass/ Fail response, but to investigate further, it is necessary to re-run Test mode from the front panel.

5-8. Interconnections

Instruments fitted with an IEEE 488 interface communicate with each other through a standard set of interconnecting cables, as specified in the IEEE 488.1 Standard document.

The IEEE 488 interface socket is fitted on the rear panel.

5-9. Operation via the IEEE 488 Interface

5-10. General

The power-up sequence is performed as in local operation. The instrument can be programmed to generate an SRQ at power-up.

5-11. Operating Conditions

When the instrument is operating under the direction of the application program, there are two main conditions, depending on whether the application program has set the 'REN' management line 'true' or 'false':

1. REN True ('REN' line low).

The instrument can be addressed and commanded if in either 'Manual' or 'Calibration' mode. All access to front panel control will be removed, except for the bottom right soft key, labeled 'Enable Local Usage'. If *LLO* (Local Lockout) has been sent with REN true, then the 'Enable Local Usage' screen key will be inoperative. If *LLO* has not been sent, the 'Enable Local Usage' screen key will return to local control as if REN were false (see 2 below).

The instrument will act in response to valid commands, performing any changes in output, etc. The display presentation will track the changes.

2. REN False ('REN' line high).

The instrument will remain in Local Operation, but can be addressed and commanded, while full access to front panel control is also retained.

The instrument will act in response to the commands, performing any changes in output, etc. No visible effect will be observed, other than the display presentation tracking the changes.

5-12. Programmed Transfer to Local Control (*GTL* or *REN False*)

The application program can switch the instrument into 'Local' Control (by sending Command *GTL*, or by setting the *REN* line *false*), permitting a user to take manual control from the front panel.

The application program can regain 'Remote' control by sending the overriding command: *Listen Address* with *REN* true (addressing the instrument as a listener with the Remote Enable management line true {Low}). This will re-impose remote control.

5-13. 'Device Clear'

Either of the commands *DCL* or *SDC* will force the following instrument states:

- All IEEE 488 input and output buffers cleared.
- With 'IFC' (Interface Clear), any device-dependent message bus hold-offs cleared.
- The status byte is changed by clearing the MAV bit.

These commands **will not**:

- Change any settings or stored data within the device except as listed above.
- Interrupt analog output.
- Interrupt or affect any functions of the device not associated with the IEEE 488 system.

5-14. Levels of Reset

Three levels of reset are defined for IEEE 488.2 application programs, a complete system reset being accomplished by resetting at all three levels, in order, to every device. In other circumstances they may be used individually or in combination:

- **IFC** Bus initialization.
- **DCL** Message exchange initialization.
- ***RST** Device initialization.

The effects of the *RST command are described in "Device settings at power on".

5-15. Message Exchange

5-16. IEEE 488.2 Model

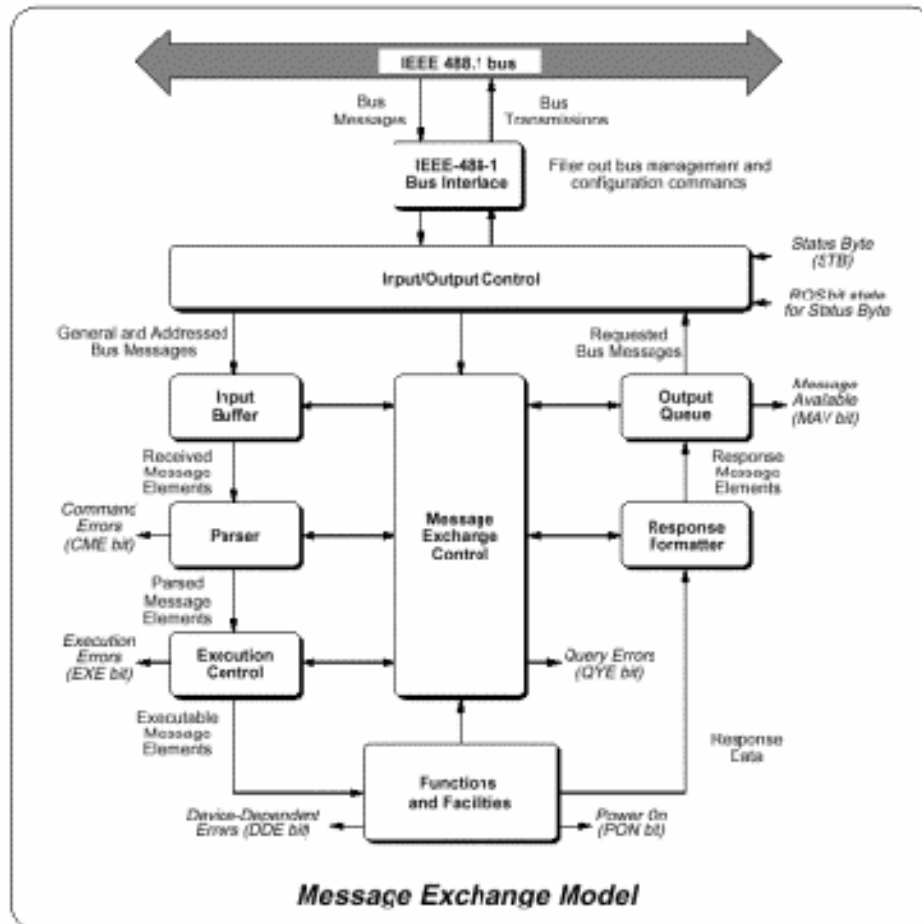

Figure 5-2. IEEE 488 Message Exchange Model

The IEEE 488.2 Standard document illustrates its Message Exchange Control Interface model at the detail level required by the device designer. Much of the information at this level of interpretation (such as the details of the internal signal paths etc.) is transparent to the application programmer. However, because each of the types of errors flagged in the Event Status Register is related to a particular stage in the process, a simplified instrument interface model can provide helpful background. This is shown below, together with brief descriptions of the actions of its functional blocks.

5-17. Instrument STATUS Subsystem

Input/ Output Control transfers messages from the instrument output queue to the system bus; and conversely from the bus to either the input buffer, or other predetermined destinations within the device interface. It receives the Status Byte from the status reporting system, as well as the state of the Request Service bit that it imposes on bit 6 of the Status Byte response. Bit 6 reflects the ‘Request Service state *true*’ condition of the interface.

5-18. **Incoming Commands and Queries**

The **Input Buffer** is a first in, first out queue, which has a maximum capacity of 1024 bytes (characters).

Each incoming character in the I/O Control generates an interrupt to the instrument processor, which places it in the Input Buffer for examination by the Parser. The characters are removed from the buffer and translated with appropriate levels of syntax checking. If the rate of programming is too fast for the Parser or Execution Control, the buffer will progressively fill up. When the buffer is full, the handshake is held.

The **Parser** checks each incoming character and its message context for correct Standard-defined generic syntax, and correct device-defined syntax. Offending syntax is reported as a **Command Error**, by setting true bit 5 (CME) of the Standard defined Event Status register (*refer to 'Retrieval of Device Status Information'*).

Execution Control receives successfully parsed messages, and assesses whether they can be executed, given the currently programmed state of the instrument functions and facilities. If a message is not viable then an Execution Error is reported, by setting true bit 4 (EXE) of the Standard defined Event Status register. Viable messages are executed in order, altering the instrument functions, facilities etc. Execution does not 'overlap' commands; instead, the instrument Execution Control processes all commands 'sequentially' (i.e. waits for actions resulting from the previous command to complete before executing the next).

5-19. **Instrument Functions and Facilities**

The instrument Functions and Facilities block contains all the device-specific functions and features of the instrument, accepting Executable Message Elements from Execution Control and performing the associated operations. It responds to any of the elements which are valid Query Requests (both IEEE 488.2 Common Query Commands and instrument Device-specific Commands) by sending any required Response Data to the Response Formatter (after carrying out the assigned internal operations).

Device dependent errors are detected in this block. Bit 3 (DDE) of the Standard Event Status register is set true when an internal operating fault is detected. Each reportable error number is appended to the Error Queue as the error occurs.

5-20. **Outgoing Responses**

The **Response Formatter** derives its information from Response Data (being supplied by the Functions and Facilities block) and valid Query Requests. From these it builds Response Message Elements, which are placed as a Response Message into the Output Queue.

The **Output Queue** acts as a store for outgoing messages, until they are read over the system bus by the application program. For as long as the output queue holds one or more bytes, it reports the fact by setting true bit 4 (Message Available MAV) of the Status Byte register. Bit 4 is set false when the output queue is empty (*refer to 'Retrieval of Device Status Information'*).

5-21. 'Query Error'

This is an indication that the application program is following an inappropriate message exchange protocol, resulting in the *Interrupted*, *Unterminated* or *Deadlocked* condition: Refer to 'Bit 2' in Event Status Register (5-10.).

The Standard document defines the instrument's response, part of which is to set *true* bit 2 (QYE) of the Standard defined Event Status register.

5-22. Request Service (RQS)

5-23. Reasons for Requesting Service

There are two main reasons for the application program to request service from the controller:

- When the instrument's message exchange interface is programmed to report a system programming error.
- When the instrument's is programmed to report significant events by RQS.

The significant events vary between types of devices; thus there is a class of events which are known as 'Device Specific'. The device designer determines these.

5-24. RQS in the IEEE 488.2 Model

The application programmer can enable or disable the event(s) which are required to originate an RQS at particular stages of the application program. The IEEE 488.2 model is extended to incorporate a flexible SCPI status reporting structure in which the requirements of the device designer and application programmer are both met.

This structure is described in '*Retrieval of Device Status Information*'.

5-25. Retrieval of Device Status Information

5-26. General

For any remotely operated system, the provision of up to date information about the performance of the system is of major importance. In the case of systems, which operate under automatic control, the controller requires the necessary feedback to enable it to progress the task; any break in the continuity of the process can have serious results.

When developing an application program, the programmer needs to test and revise it, knowing its effects. Confidence that the program elements are couched in the correct grammar and syntax (and that the program commands and queries are thus being accepted and acted upon), helps to reduce the number of iterations needed to confirm and develop the viability of the whole program. Such information is given in the following pages.

5-27. IEEE 488 and SCPI Standard defined Features

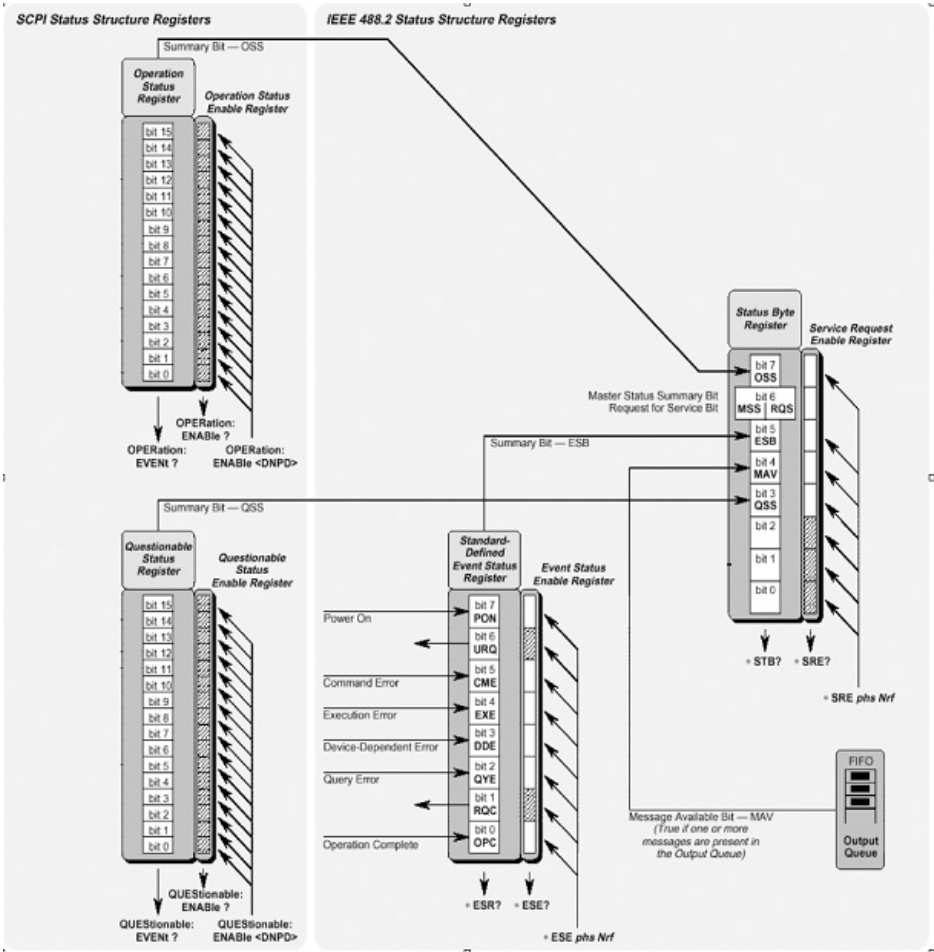

Figure 5-3. IEEE-488 and SCPI Standard Defined Features

5-28. Status Summary Information and SRQ

The Status Byte consists of four 'summary' bits which notify events in the 8 bit latched IEEE-488.2 defined 'Event Status Register' (ESB), the two 16 bit latched SCPI defined registers (OSS & QSS), and the Output Queue (MAV). Whenever one of these summary bits is enabled and set *true*, the Status Byte summary bit (MSS) is also set *true*. The buffered bit 'RQS' follows *true* when MSS goes true, and will set the IEEE 488 SRQ line *true* (Note that in the diagram above no arrow points at bit 6 of the Service Request Enable Register - bit 6 is always enabled).

A subsequent serial poll by the Application Program will discover that the instrument was the requesting device (while resetting RQS *false* again, MSS remaining *true*), and which of the summary bits is *true*. The *STB? command is an equivalent command to serial poll, where serial poll is not available.

5-29. Event Register Conditions

The Status Byte summary bits direct the application program down the structure towards causal events.

ESB and MAV are standard IEEE-488 features, described in detail in 'Instrument Status Reporting IEEE 488.2 basics) OSS and QSS are features of the SCPI structure, described in 'Instrument Status Reporting SCPI Element'.

5-30. Access via the Application Program

Referring to figure at the beginning of this sub-section take as an example the main Event Status register:

- **Enabling the Events**

The main *Standard-Defined Event Status Register* has a second *Event Status Enable Register*. A program command (*ESE *phs Nrf*) can be used to set the state of the bits in the *Enable* register. This enables or disables the events, which will set the main register's summary bit *true*.

- **Reading the Enable Register**

A 'query' command (*ESE?) permits the application program to read the state of the *Enable* register, and hence find out which events are enabled to be reported.

- **Reading the Main Register**

Another 'query' command (*ESR?) reads the state of the main *Standard-Defined* register, to discover which event has occurred (i. e. has caused the summary bit to be set *true*). Reading this register clears all its bits.

- **Reporting the Event**

If an event is to be reported via the SRQ, its corresponding *enable* bit will have been set *true*, (using the number *Nrf*). Each bit in the *Standard-Defined* register remains in *false* condition unless its assigned event occurs, when its condition changes to *true* and remains *true* until cleared by *ESR? or *CLS. This causes the register's summary bit in the Status Byte also to be set *true*. If this bit is enabled, then the Status Byte *bit 6* (MSS/ RQS) will be set *true*, and the instrument will set the IEEE-488 bus SRQ line *true*.

- **SCPI Status Registers**

The two SCPI Status registers operate in the same way, using the appropriate program commands to set the enable registers, and query commands to discover the condition of the registers (the 6100A does not make use of these registers).

- **Subsequent Action**

Thus the application programmer can enable any assigned event to cause an SRQ, or not. The controller can be programmed to read the Status Byte, using a serial poll to read the Status Byte register and the *true* summary bit (ESB or MAV). The application program then investigates the appropriate event structure until the causal event is discovered. The detail for each register is expanded in the following paragraphs, and in the command descriptions.

5-31. Instrument Status Reporting IEEE 488.2 Basics

5-32. IEEE 488.2 Model

This develops the IEEE 488.1 model into an extended structure with more definite rules. These rules invoke the use of standard ‘Common’ messages and provide for device-dependent messages. A feature of the structure is the use of ‘Event’ registers, each with its own enabling register as shown in ‘Retrieval of Device Status Information’.

5-33. Instrument Model Structure

The IEEE 488.2 Standard provides for an extensive hierarchical structure with the Status Byte at the apex, defining its bits 4, 5 and 6 and their use as summaries of a *Standard-defined* event structure, which must be included if the device is to claim conformance with the Standard. The instrument employs these bits as defined in the Standard.

Bits 0, 1, 2 and 3 and 7 are available to the device designer; only bits 3 and 7 are used in the instrument, and these are as defined by the SCPI standard. The application programmer must recognize that whenever the application program reads the Status Byte, it can only receive summaries of types of events, and further query messages will be needed to probe the details relating to the events themselves. For example: a further byte is used to expand on the summary at bit 5 of the Status Byte.

5-34. Status Byte Register

In this structure the Status Byte is held in the ‘Status Byte Register’; the bits being allocated as follows:

- **Bits: 0 (DIO1), 1 (DIO2) and 2 (DIO3)** are not used in the instrument status byte. They are always *false*.
- **Bit 3** summarizes the state of the ‘Questionable Status data’, held in the ‘Questionable Status register’ (QSR), whose bits represent SCPI-defined and device-dependent conditions in the instrument. The QSS bit is *true* when the data in the QSR contains one or more enabled bits, which are *true*, or *false*, when all the enabled bits in the byte are *false*. The SCPI Standard defines the QSR and its data, (not used in 6100A).
- **Bit 4 (DIO5)** IEEE 488.2 defined Message Available Bit (MAV).

The MAV bit helps to synchronize information exchange with the controller. It is *true* when a message is placed in the Output Queue; or *false* when the Output Queue is empty. The common command *CLS can clear the Output Queue and the MAV bit 4 of the Status Byte Register; providing it is sent immediately following a ‘Program Message Terminator’.

- **Bit 5 (DIO6)** IEEE 488.2 defined Standard Event Summary Bit (ESB).

Summarizes the state of the ‘Event Status byte’, held in the ‘Event Status register’ (ESR), whose bits represent IEEE 488.2 defined conditions in the

device. The ESB bit is *true* when the byte in the ESR contains one or more enabled bits which are *true*; or *false* when all the enabled bits in the byte are *false*.

- **Bit 6** (DIO7) is the Master Status Summary Message (MSS bit), and is set *true* if one of the bits 0 to 5 or bit 7 is *true* (bits 0, 1 and 2 are always *false* in the instrument).
- **Bit 7** (DIO4) SCPI defined Operation Status Summary Bit (QSS).

Summarizes the state of the 'Operation Status data', held in the 'Operation Status register' (OSR), whose bits represent processes in progress in the instrument. The OSS bit is *true* when the data in the OSR contains one or more enabled bits which are *true*, or *false* when all the enabled bits in the byte are *false*. The OSR is not used in the 6100A.

5-35. *Reading the Status Byte Register*

The common query: `*STB?` reads the binary number in the Status Byte register. The response is in the form of a decimal number that is the sum of the binary weighted values in the enabled bits of the register. In the instrument, the binary weighted values of bits 0, 1 and 2 are always zero.

5-36. *Service Request Enable Register*

The SRE register is a means for the application program to select, by enabling individual Status Byte summary bits, those types of events which are to cause the instrument to originate an RQS. It contains a user modifiable image of the Status Byte, whereby each *true* bit acts to enable its corresponding bit in the Status Byte.

The common program command: `*SRE phs Nrf` performs the selection, where *Nrf* is a decimal numeric, whose binary decode is the required bit pattern in the enabling byte.

For example:

If an RQS is required only when a Standard-defined event occurs and when a message is available in the output queue, then *Nrf* should be set to 48. The binary decode is 00110000 so bit 4 or bit 5, when *true*, will generate an RQS; but with this decode, even if bit 3 is *true*, no RQS will result. The instrument always sets *false* the Status Byte bits 0, 1 and 2, so they can never originate an RQS whether enabled or not.

5-37. *Reading the Service Request Enable Register*

The common query: `*SRE?` reads the binary number in the SRE register. The *response* is in the form of a decimal number, which is the sum of the binary-weighted values in the register. The binary weighted values of bits 0, 1 and 2 will always be zero.

5-38. *IEEE 488.2 defined Event Status Register*

The 'Event Status Register' holds the Event Status Byte, consisting of event bits, each of which directs attention to particular information. All bits are 'sticky', i.e. once *true*, cannot return to *false* until the register is cleared. This occurs automatically when it is read by the query `*ESR?`. The common command `*CLS` clears the Event Status Register and associated error queue, but not the Event Status Enable Register.

Note that because the bits are 'sticky', it is necessary to read the appropriate subordinate register of the status structure in order to clear *its* bits and allow a new event from the same source to be reported.

The 'Event Status Register' bits are named in mnemonic form as follows:

- **Bit 0** Operation Complete (OPC).

This bit is *true* only if *OPC has been programmed and all selected pending operations are complete. As the instrument operates in serial mode, its usefulness is limited to registering the completion of long operations, such as self test.

- **Bit 1** Request Control (RQC).

This bit is not used in the instrument. It is always set *false*.

- **Bit 2** Query Error (QYE).

QYE *true* indicates that the application program is following an inappropriate message exchange protocol, resulting in the following situations:

- **Interrupted Condition.** When the instrument has not finished outputting its **Response Message** to a **Program Query**, and is interrupted by a new **Program Message**.
- **Unterminated Condition.** When the application program attempts to read a **Response Message** from the instrument without having first sent the complete **Query Message** (including the **Program Message Terminator**) to the instrument.
- **Deadlocked Condition.** When the input and output buffers are filled, with the parser and the execution control blocked.

- **Bit 3** Device Dependent Error (DDE).

DDE is set *true* when an internal operating fault is detected, and the appropriate error message is added to the Error Queue. See the 'Note about the Error Queue' below:

Note about the ERROR Queue

The Error Queue is a sequential memory stack. Each reportable error has been given a listed number and explanatory message, which are entered into the error queue as the error occurs. The queue is read destructively as a First In/ First Out stack, using the query command SYSTem:ERRor? to obtain a code number and message.

Repeated use of the query SYSTem:ERRor? will read successive Device Dependent, Command and Execution errors until the queue is empty, when the 'Empty' message (0, "NO error") will be returned.

*It would be good practice to repeatedly read the Error Queue until the 'Empty' message is returned. The common command *CLS clears the queue.*

- **Bit 4** Execution Error (EXE).

An execution error is generated if the received command cannot be executed, owing to the device state or the command parameter being out of bounds. The appropriate error message is added to the Error Queue.

See the 'Note about the Error Queue' above.

- **Bit 5** Command Error (CME).

CME occurs when a received bus command does not satisfy the IEEE 488.2 generic syntax or the device command syntax programmed into the instrument interface's parser, and so is not recognized as a valid command. The appropriate error message is added to the Error Queue. See the 'Note about the Error Queue' above.

- **Bit 6** User Request (URQ).

This bit is not used. It is always set *false*.

- **Bit 7** Instrument Power Supply On (PON).

This bit is set *true* only when the Line Power has just been switched on to the instrument.

Whether or not an SRQ is generated by setting bit 7 *true*, depends on the previously-programmed 'Power On Status Clear' message **PSC phs Nrf*:

- For an *Nrf* of 1, the Event Status Enable register would have been cleared at power on, so PON would not generate the ESB bit in the Status Byte register, and no SRQ would occur at power on.
- If *Nrf* was 0, and the Event Status Enabling register bit 7 *true*, and the Service Request Enabling register bit 5 *true*; a change from Power Off to Power On will generate an SRQ. This is only possible because the enabling register conditions are held in non volatile memory, and restored at power on. This facility is included to allow the application program to set up conditions so that a momentary Power Off followed by reversion to Power On (which could upset the instrument programming) will be reported by SRQ.

To achieve this, the Event Status register bit 7 must be permanently *true* (by **ESE phs Nrf*, where $Nrf \geq 128$); the Status Byte Enable register bit 5 must be set permanently *true* (by command **SRE phs Nrf*, where *Nrf* lies in one of the ranges 32 - 63, 96 - 127, 160 - 191, or 224 - 255); Power On Status Clear must be disabled (by **PSC phs Nrf*, where $Nrf = 0$); and the Event Status register must be read destructively immediately following the Power On SRQ (by the common query **ESR?*).

5-39. Standard Event Status Enable Register

The ESE register is a means for the application program to select, from the positions of the bits in the Standard defined Event Status Byte, those events which when *true* will set the ESB bit *true* in the Status Byte. It contains a user-modifiable image of the standard Event Status Byte, whereby each *true* bit acts to enable its corresponding bit in the standard Event Status Byte.

The program command: **ESE phs Nrf* performs the selection, where *Nrf* is a decimal numeric, which when decoded into binary, produces the required bit pattern in the enabling byte.

For example:

If the ESB bit is required to be set *true* only when an execution or device dependent error occurs, then *Nrf* should be set to 24. The binary decode is 00011000 so bit 3 or bit 4, when *true*, will set the ESB bit *true*; but when bits 0 - 2, or 5 - 7 are *true*, the ESB bit will remain *false*.

5-40. Reading the Standard Event Enable Register

The common query: *ESE? reads the binary number in the ESE register. The response is a decimal number, which is the sum of the binary-weighted values in the register.

5-41. The Error Queue

As errors in the instrument are detected, they are placed in a 'first in, first out' queue, called the 'Error Queue'. This queue conforms to the format described in the SCPI Command Reference (Volume 2) Chapter 19, paragraph 19.7, although only errors are detected. Three kinds of errors are reported in the error queue: *command* errors, *execution* errors and *device-specific* errors.

The queue is read destructively, as described in the SCPI Command Reference, using the query command 'SYSTem:ERRor?'. This command will return a code number and error message. The query SYSTem:ERRor? can be used to read errors in the queue until it is empty, (when the message '0, No Error' will be returned).

5-42. Instrument Status Reporting — SCPI Elements**5-43. General**

In addition to IEEE 488.2 status reporting the instrument implements the Operation and Questionable Status registers with associated 'Condition', 'Event' and 'Enable' commands.

The extra status deals with current operation of the instrument and the quality of operations.

The structure of these two registers is detailed in the diagram at the beginning of 'IEEE-488 and SCPI Standard defined Features section', together with the nature of the reported events. Access to the registers is detailed in the STATus subsystem of the 'SCPI Commands and Syntax' section of this document.

5-44. SCPI Status Registers

The SCPI states are divided into two groups, reporting from the Operation or Questionable Status event register. Each Status register has its own 'Enable' register, which can be used as a mask to enable bits in the event register itself, in a similar way to that set by the *ESE command for the Standard Event status Register (ESR).

Each Status Register is associated with its own third 'Condition' register, in which the bits are not 'sticky', but are set and reset as the internal conditions change.

Each Enable Register can be commanded to set its mask to enable selected bits in the corresponding Event Register. All registers (Event, Enable and Condition) can be interrogated by appropriate 'Queries' to divulge their bits' states.

5-45. Reportable SCPI States

The 6100A does not normally use the Operation Status Event Register, but future hardware options may make use of it (for example, the energy counter/timer option).

5-46. SCPI Programming Language.

Standard Commands for Programmable Instruments (SCPI) is an instrument command language which goes beyond *IEEE 488.2* to address a wide variety of instrument functions in a standard manner.

IEEE 488.2 defines sets of *Mandatory Common Commands* and *Optional Common Commands* along with a method of *Standard Status Reporting*. The instrument implementation of SCPI language conforms to all IEEE 488.2 mandatory commands but not all optional commands. It conforms to the SCPI approved status reporting method.

Note: Commands in SCPI language, prefaced by an asterisk (e.g.: *CLS), are IEEE-488.2 standard-defined '*Common*' commands. Conformance of the instrument remote programming commands to SCPI ensures that the instrument has a high degree of consistency with other conforming instruments.

SCPI commands are easy to learn, self-explanatory and account for a wide variety of usage skills. The full range of instrument commands, with their actions and meanings in the instrument, is detailed in alphabetical order in '*SCPI Commands and Syntax*'. The IEEE 488 Common Commands implemented in The 6100A Electrical Power Standard, together with their operating information are given in '*Common Commands and Queries*'.

Keyword	Parameter Form	Notes
:CURRent :RANGe :RANGe? :VOLTage :VOLTage(?) :UNIT?	<dnpd>, <dnpd> [<cpd> {LOW HIGH}] <dnpd>, <dnpd> [<cpd>{ LOW HIGH }]	Calibration range: <dnpd> = Low limit, High limit. Calibration range query. <dnpd> = low limit, high limit.
:ACTual :FREQuency?	<dnpd>,<dnpd>	Response is VOLT (voltage) or CURR (current). Query only. <dnpd> = Amplitude, Angle. Note: Angle relative to master phase. Query only of Actual frequency.
:TARGet	<dnpd>[,<dnpd>,<dnpd>,<dnpd>,<dnpd>]	<dnpd> = Target point. Or, <dnpd> = Point, Fund Freq, Harmonic, Amplitude, Angle. Note1: Angle relative to master phase. Note2: Second form is only required when changing target point.
:TRIGger? :STORe :DUMP?		Dump all stores for active range: Point,<target data>,<actual data>), ... <target data> = Fund, Harm, Ampl, Angle <actual data> = Freq, Ampl, Angle

Keyword	Parameter Form	Notes
OUTPut		
[:STATe](?)	<bool> {OFF ON 0 1}	
:ROSCillator		
[:STATe](?)	<bool> {OFF ON 0 1}	
:SENSe(?)	<bool> {OFF ON 0 1}	
:DEFer(?)		
[:STATe](?)	<bool> {OFF ON 0 1}	
:ACTion	[<cpd> {APPLy UNDO}]	
[SOURce]		
:FREQuency(?)	<dnpd>	
:LINE(?)	<bool> {OFF ON 0 1}	
:LOCKed?		
:PHASe<x>		<x> is phase (1 to 4). 1 is master phase.
:FITTed(?)		
:SERial?		Serial number of phase.
:POWer		
[:WATTs]?		
:VA?		
:PFACTOR?		
:BUDeanu?	[<cpd> { P S Q D}]	
:FRYZe?	[<cpd> { P S Q}]	
:KUSTers?	[<cpd> { P S QC QCR QL QLR}]	
:SHEPherd?	[<cpd> { P S SR SX SD}]	
:SHARon?	[<cpd> { P S SQ SC}]	
:IEEE?	[<cpd> { P S N SN P1 S1 Q1 PH SH NH}]	
:VOLTage		
[:STATe](?)	<bool> {OFF ON 0 1}	
:RANGe	<dnpd>, <dnpd>	<dnpd> = Low limit, High limit.
:RANGe?	[<cpd> {LOW HIGH}]	
:AMPLitude?		Absolute final output amplitude. Query only.
:MHARmonics		
[:STATe](?)	<bool> {OFF ON 0 1}	
:CLEar		
:AMPLitude(?)	<dnpd>	<dnpd> = RMS amplitude.
:HARMonic<y>	<dnpd>,<dnpd>	<y> is harmonic number. <dnpd> = Amplitude, Phase. Note: amplitude absolute or % depending on value of UNIT:MHAR:...
:AMPLitude(?)	<dnpd>	Absolute or %
:PANGle(?)	<dnpd>	
:HARMonic<y>?	[<cpd> {AMPLitude PANGle}]	
:ALL?	[<cpd> {AMPLitude PANGle}]	Response is in csv format.

Keyword	Parameter Form	Notes
:FHARmonics		
[:STATE](?)	<bool>{OFF ON 0 1}	
:CLEar		
:FLUCtuate<y>(?)	<bool>{OFF ON 0 1}	<y> is harmonic number.
:ALL?		Response in csv format.
:MODulation	<dnpd>,<dnpd>	<dnpd> = Depth, Frequency.
:MODulation?	[<cpd>{ DEPT h FREQuency }]	
:SHAPE(?)	<cpd>{ RECTangular SINusoidal SQUARE}	
:DUTY(?)	<dnpd>	
:IHARmonics		
[:STATE](?)	<bool>{OFF ON 0 1}	
:SIGNal<y>	<bool>{OFF ON 0 1},<dnpd>,<dnpd>	<y> = signal (1 or 2). <dnpd> = Amplitude, Frequency.
:SIGNal<y>?	[<cpd>{ STATE AMPLitude FREQuency }]	
:DIP		
[:STATE](?)	<bool>{OFF ON 0 1}	
:ENvelope	<dnpd>,<dnpd>,<dnpd>,<dnpd>,<dnpd>	<dnpd> = Change to, Ramp in, Duration, Ramp out, End Delay
:ENvelope?	[<cpd>{CHANge RIN DURation ROUT EDELay}]	
:TRIGger		
:INPut(?)	<cpd>{ FREE EONE EREPeat}	
:ODELay(?)	<dnpd>	
:HOLDoff(?)	<cpd>{ PHASe DELay },<dnpd>	<dnpd> units depends on the <cpd>.
:FLICKer		
[:STATE](?)	<bool>{ OFF ON 0 1 }	
:FREQuency(?)	<dnpd>	
:DEPT h(?)	<dnpd>	
:PST?		
:SHAPE(?)	<cpd>{ RECTangular SINusoidal SQUARE}	
:DUTY(?)	<dnpd>	

Keyword	Parameter Form	Notes
:CURRent		
[:STATe](?)	<bool>{OFF ON 0 1}	
:RANGe	<dnpd>, <dnpd>	<dnpd> = low limit, high limit
:RANGe?	[<cpd>{ LOW HIGH }]	
:VOLTage	<dnpd>, <dnpd>	<dnpd> = low limit, high limit
:VOLTage(?)	[<cpd>{ LOW HIGH }]	
:UNIT?		Response is VOLT (voltage) or CURR (current). Query only.
:AMPLitude?		Absolute final output amplitude. Query only.
:BANDwidth(?)	[<cpd>{NORMAL LOW}]	
:MHARmonics		
[:STATe](?)	<bool>{OFF ON 0 1}	
:CLEar		
:AMPLitude(?)	<dnpd>	<dnpd> = RMS amplitude.
:HARMonic<y>	<dnpd>,<dnpd>	<y> is harmonic number. <dnpd> = Amplitude, Phase. Note: amplitude absolute or % depending on value of UNIT:MHAR...
:AMPLitude(?)	<dnpd>	
:PANGLe(?)	<dnpd>	
:HARMonic<y>?	[<cpd>{ AMPLitude PANGLe }]	
:ALL?	[<cpd>{ AMPLitude PANGLe }]	Response is in CSV format.
:FHARmonics		
[:STATe](?)	<bool>{OFF ON 0 1}	
:CLEar		
:FLUCtuate<y>(?)	<bool>{OFF ON 0 1}	<y> is harmonic number.
:ALL?		Response in CSV format.
:MODulation	<dnpd>,<dnpd>	<dnpd> = Depth, Frequency.
:MODulation?	[<cpd>{ DEPTH FREQUENCY }]	
:SHAPE(?)	<cpd>{ RECTangular SINusoidal SQUARE}	
:DUTY(?)	<dnpd>	
:IHARmonics		
[:STATe](?)	<bool>{OFF ON 0 1}	
:SIGNAL<y>	<bool>{OFF ON 0 1}[,<dnpd>,<dnpd>]	<y> = Signal (1 or 2). <dnpd> = Amplitude, Frequency.
:SIGNAL<y>?	[<cpd> {STATE AMPLitude PANGLe}]	

Keyword	Parameter Form	Notes
:DIP		
[:STATE](?)	<bool>{OFF ON 0 1}	
:ENVELOpe	<dnpd>,<dnpd>,<dnpd>,<dnpd>,<dnpd>	<dnpd> = Change to, Ramp in, Duration, Ramp out, End Delay
:ENVELOpe?	[<cpd>{CHANGe RIN DURation ROUT EDELay}]	
:TRIGger		
:INPut(?)	<cpd>{ FREE EONE EREPeat}	
:ODELay(?)	<dnpd>	
:HOLDoff(?)	<cpd>{ PHASe DELay },<dnpd>	<dnpd> units depends on the <cpd>.
:FLICKer		
[:STATE](?)	<bool>{ OFF ON 0 1 }	
:FREQUency(?)	<dnpd>	
:DEPTH(?)	<dnpd>	
:PST?		
:SHAPE(?)	<cpd>{ RECTangular SINusoidal SQUARE}	
:DUTY(?)	<dnpd>	
STATUS		
:OPERation		
[:EVENT]?		Query only.
:ENABle(?)	<dnpd>	
:CONDition?		Query only.
:QUESTionable		
[:EVENT]?		Query only.
:ENABle(?)	<dnpd>	
:CONDition?		Query only.
:PRESet		
SYSTEM		
:ERRor?		Query only.
:DATE(?)	<dpnd>,<dpnd>,<dpnd>	<dnpd> = Year, Month, Day.
:TIME(?)	<dpnd>,<dpnd>,<dpnd>	<dnpd> = Hour, Minute, Second.
:VERSion?		Query only.
:UNIT		
:ANGLE(?)	<cpd> {DEGrees RADIans}	Selection affects all phase angle entries.
:MHARmonics		
:CURRent(?)	<cpd> {PRMS PFUNDamental DBFundamental ABSolute}	
:VOLTage(?)	<cpd> {PRMS PFUNDamental DBFundamental ABSolute}	
:DIP		
:TIME(?)	<cpd> {SEConds CYCLes}	

5-49. Calibration Subsystem Command Details

This subsystem is used to calibrate the functions and hardware ranges of the 6100A. This will correct for any system errors due to drift or ageing effects.

Before any adjustments can take place, access to calibration must be enabled.

There is a switch (on the rear panel of the 6100A, marked CALIBRATION) that must be set to ENABLE. Having done this, the calibration password command must be sent. Once entered into *calibration mode*, only calibration commands are accepted; these can then be used to adjust the instrument.

CALibration:SECure:PASSword <spd>

This command is used to gain access to calibration mode. The <spd> must be the correct 'calibration' password registered in the 6100A software. The calibration password can be changed only in calibration mode, (from the 6100A front panel).

CALibration:SECure:EXIT

This command is used to exit calibration mode, and return to normal operation, any pending adjustment operations will be cancelled.

CALibration:PHASe<x>:VOLTage:RANGe <dnpd>,<dnpd>

This command sets the specified phase's voltage channel hardware range:

- The first parameter is the lower limit that the range must cover.
- The second parameter is the upper limit that the range must cover.

The instrument determines the narrowest amplitude range that encompasses the limits.

CALibration:PHASe<x>:VOLTage:RANGe? [<cpd>{ LOW | HIGH }]

The default version will return the low and high limits of the presently selected range, (comma separated). Add the appropriate optional parameter to query just one of these values.

CALibration:PHASe<x>: VOLTage:ACTual <dnpd>,<dnpd>

This command is used to change the actual values that the calibration will take place at:

- The first parameter is the amplitude (interpreted as an absolute voltage).
- The second parameter is the phase angle (interpreted according to the active setting of the **UNIT:ANGLE** command, i.e. Degrees or Radians).

CALibration:PHASe<x>: VOLTage:ACTual:FREQuency?

This command is used to query the frequency the adjustment will take place at.

Note: The frequency itself is not adjustable.

CALibration:PHASe<x>:VOLTage:TARGe<dnpd>[,<dnpd>,<dnpd>,<dnpd>,<dnpd>]

For each calibration operation, the required calibration point (factor) must be targeted. This command is used to select this point, and also permits the user to define parameters associated with the calibration point in the current operation:

- The first <dnpd> is an integer (from 0 to 2) that indicates the target point to adjust.

Note: This corresponds to the list of target entries on the 'adjust instrument' screen, (in the target field), for the corresponding function and hardware range.

- The subsequent (and optional) <dpnd>'s correspond to the fundamental frequency, harmonic number, absolute amplitude and phase angle of this point. These parameters allow the target point itself to be moved. In practice, the factory set target defaults should not require modification, so the non-optional form of the command should be all that is required.

Once a target has been set, the 6100A adjustment is restricted to values within the selected hardware voltage span, and frequency band. In order to release this restriction, one of the following commands must be sent:

TRIG?, EXIT or a new TARG command.

CALibration:PHASe<x>:VOLTage:TRIGer?

After the parameters are set for calibration at a single calibration point, this command initiates the internal calibration process. This command applies to the TARGeT settings.

The response returns a '0' for success, and a '1' for failure. In this latter case an error message is put in the error queue.

Note: The current channel calibration commands are the same as voltage above, but replace 'VOLT' with 'CURR'.

The exceptions to this rule are as follows:

CALibration:PHASe<x>:CURRent:RANGe:VOLTage <dpnd>,<dpnd>

This command sets the specified phase's current channel hardware range to output a voltage instead of a current. The first parameter is the lower limit that the range must cover. The second parameter is the upper limit that the range must cover. The instrument determines the narrowest amplitude range that encompasses the limits.

For reference purposes, note that the following ranges are presently defined:

Range	Lower Limit	Upper Limit
0.5V range	0.05V	0.25V
1V range	0.15V	1.5V
10V range	1V	10V

CALibration:PHASe<x>:CURRent:RANGe:VOLTage? [<cpd>{ LOW | HIGH }]

The default version will return the low and high limits of the presently selected range, comma separated. Use the parameters to query just one of these values.

CALibration:PHASe<x>:CURRent:RANGe:UNIT?

This query only command can be used to check whether the voltage out of current ranges are in use.

The response is:

- CURRent An ordinary current range is active.
- VOLTage A voltage out of current range is active.

5-50. Output Subsystem Command Details**OUTPut[:STATe](?) <bool>{OFF|ON|0|1}**

This command turns the instrument's output on or off, dependent upon the individual Voltage and Current channel output settings of each phase.

- ON or 1 will set the output on.
- OFF or 0 will set the output off.

The query command returns 1 if the output is on, or 0 if the output is off.

OUTPut:ROSCillator[:STATe](?) <bool>{OFF|ON|0|1}

This command turns the instrument's reference oscillator signal on or off.

- ON or 1 will enable the generation of a sample reference signal.
- OFF or 0 will disable the generation of a sample reference signal.

The query command returns 1 if reference oscillator is on, or 0 if reference oscillator is off.

OUTPut:SENSe(?) <bool>{OFF|ON|0|1}

This command turns the instrument's 2-wire or 4-wire sense capability on or off.

- ON or 1 will select 4-wire sensing.
- OFF or 0 will select 2-wire sensing.

The query command returns 1 if 4-wire sensing is on, or 0 if 2-wire sensing is on.

OUTPut:DEFer[:STATe](?) <bool>{OFF|ON|0|1}

This command sets the deferred or direct operating mode.

When deferred mode is active, all commands that effect the output signal of the master instrument and phases, are buffered until the instrument receives an *apply* or *undo* operation. At this point, the actual output signal on all phases is updated to reflect the buffered state, or the buffered state is undone.

- ON or 1 will enable deferred mode.
- OFF or 0 will disable deferred mode, and return the instrument to direct operation.

The query command returns 1 if deferred mode is on, or 0 if deferred mode is off.

Note: The instrument will default to direct mode.

OUTPut:DEFer:ACTion <cpd>{APPLY | UNDO}

This command will *apply* or *undo* any pending (buffered) command that have been received when in deferred mode.

- APPLY will act upon those commands last received since the last apply/undo.
- UNDO will discard any commands received since the last apply.

The command has no query form. Note that it will report a 'settings conflict' if DEFer mode is not ON.

Note: operations which are invalid when the output is ON are also invalid when Deferred mode is active, even if the output is OFF. For example you cannot change range in Deferred mode even if the output is OFF

5-51. Source Subsystem Command Details

5-52. General Commands

SOURce:FREQuency(?) <dnpd>

This command is used to set the fundamental frequency for all voltage and current channels on all phases. The <dnpd> is a number, which sets the required fundamental frequency, expressed in Hz. It will automatically choose the 'best' hardware range for the defined frequency of output.

The query version will return the present output frequency value. The returned number will be in standard scientific format (300 Hz would be returned as 3 . 0E2).

SOURce:FREQuency:LINE(?) <bool>{OFF|ON|0|1}

This command is used to set the line locking of the frequency for all voltage and current channels on all phases.

- ON or 1 will select line locking.
- OFF or 0 will select line locking

The query command will return 1 if line locking is enabled, or 0 if line locking is disabled.

SOURce:FREQuency:LOCK?

This query only command returns line lock state:

- 1 indicates that line-lock has been achieved.
- 0 indicates that line lock has not been achieved.

SOURce:PHASe<x>:FITTed?

This command is a query only and is used to return whether or not a phase is present.

The query version returns 1 if the phase is present and 0 otherwise.

SOURce:PHASe<x>:SERIAL?

This command is used to get the serial number of an instrument.

The query response is a <spd>, for example "12345"

5-53. *Power Values*

SOURce:PHASe<x>:POWer:WATT?

This command is a query only and is used to return a Phase's Power value in units of Watts (this is always the same irrespective of the reactive power calculation method).

The instrument will return the specified Phase's output power value. The returned number will be in standard scientific format (24.3kW would be returned as 2.43E4).

SOURce:PHASe<x>:POWer:VA?

This command is a query only and is used to return a Phase's Power value in units of VA (this is always the same irrespective of the power calculation).

The instrument will return the specified Phase's output power value. The returned number will be in standard scientific format (453.6VA would be returned as 4.536E2).

SOURce:PHASe<x>:POWer:PFACtor?

This command is a query only and is used to return a Phase's Power Factor value (this is always the same irrespective of the power calculation).

SOURce:PHASe<x>:POWer:BUDeanu? [<cpd>{ P | S | Q | D }]

This command is a query only. The default (no parameter) version will return all of the components from a calculation of the Phase's Power according to Budeanu in comma separated format, in the order P, S, Q, D. The parameters select a specific component to return. The returned numbers will be in standard scientific format.

Example:

```
1.0E1, 1.141E1, 0.0E0, 0.0E0
```

Note:

P is identical to WATT.
 S is identical to VA.

SOURce:PHASe<x>:POWer:FRYZe? [<cpd>{ P | S | Q }]

This command is a query only. The default (no parameter) version will return all of the components from a calculation of the Phase's Power according to Fryze in comma separated format, in the order P, S, Q. The parameters select a specific component to return. The returned numbers will be in standard scientific format.

Example:

```
1.0E1, 1.141E1, 0.0E0
```

Note:

P is identical to WATT.
 S is identical to VA.

SOURce:PHASe<x>:POWer:KUSTers? [<cpd>{ P | S | QC | QCR | QL | QLR }]

This command is a query only. The default (no parameter) version will return all of the components from a calculation of the Phase's Power according to Kusters & Moore in comma separated format, in the order P, S, Qc, Qcr, Ql, Qlr. The parameters select a specific component to return. The returned numbers will be in standard scientific format.

Example:

```
1.0E1, 1.414E1, 0.314E0, 0.1E0, 0.207E0, 0.207E0
```

Note:

P is identical to WATT.
 S is identical to VA.

SOURce:PHASe<x>:POWer:SHEPherd? [<cpd>{ P | S | SR | SX | SD }]

This command is a query only. The default (no parameter) version will return all of the components from a calculation of the Phase's Power according to Shepherd & Zakikhani in comma separated format, in the order P, S, Sr, Sx, Sd. The parameters select a specific component to return. The returned numbers will be in standard scientific format.

Example:

```
1.0E1, 1.414E1, 1.314E0, 0.1E0, 0.0E0
```

Note:

P is identical to WATT.

S is identical to VA.

SOURce:PHASe<x>:POWer:SHARon? [<cpd>{ P | S | SQ | SC }]

This command is a query only. The default (no parameter) version will return all of the components from a calculation of the Phase's Power according to Sharon & Czarnecki in comma separated format, in the order P, S, Sq, Sc. The parameters select a specific component to return. The returned numbers will be in standard scientific format.

Example:

```
1.0E1, 1.414E1, 1.314E0, 0.1E0
```

Note:

P is identical to WATT.

S is identical to VA.

SOURce:PHASe<x>:POWer:IEEE? [<cpd>{ P | S | N | SN | P1 | S1 | Q1 | PH | SH | NH }]

This command is a query only. The default (no parameter) version will return all of the components from a calculation of the Phase's Power according to the IEEE Working Group on Harmonics in comma separated format, in the order P, S, N, SN, P1, S1, Q1, PH, SH, NH. The parameters select a specific component to return. The returned numbers will be in standard scientific format.

Example:

```
1.0E1, 1.414E1, 1.314E0, 0.1E0, 0.0E0, 0.7E1, 0.8E1, 0.1E1, 0.3E1  
, 0.614E1, 1.2E-3
```

Note:

P is identical to WATT.

S is identical to VA.

5-54. Voltage Setup

SOURce:PHASe<x>:VOLTage:STATe(?) <bool>{OFF|ON|0|1}

This command will make the specified Phase's Voltage channel enabled or disabled.

- ON or 1 will enable the channel.
- OFF or 0 will disable the channel.

The query command returns 1 if channel enabled, or 0 if channel is disabled.

SOURce:PHASe<x>:VOLTage:RANGe <dpnd>,<dpnd>

This command sets the specified Phase's Voltage channel hardware range. The first parameter is the lower limit that the range must cover. The second parameter is the upper limit that the range must cover. The instrument determines the narrowest amplitude range that encompasses the limits.

For reference purposes, note that the following ranges are presently defined:

Range	Lower Limit	Upper Limit
11V range	1.0V	16V
23V range	2.3V	33V
56V range	5.6V	78V
110V range	11V	168V
230V range	23V	336V
560V range	56V	1008V

SOURce:PHASe<x>:VOLTage:RANGe? [<cpd>{ LOW | HIGH }]

The default version will return the low and high limits of the presently selected range, comma separated. Add the appropriate optional parameter to query just one of these values.

SOURce:PHASe<x>:VOLTage:AMPLitude?

This query only command is used to find out the specified phase's output amplitude, in RMS Volts.

The instrument will return the present voltage value. The returned number will be in standard scientific format (550V would be returned as 5.5E2).

5-55. DC and Harmonics Phenomenon

SOURce:PHASe<x>:VOLTage:MHARmonics:STATe(?) <bool>{OFF|ON|0|1}

This command turns the specified phase's voltage channel harmonics phenomena on and off, toggling it with the sine mode:

- ON or 1 will enable Harmonics mode, disabling sine mode.
- OFF or 0 will disable Harmonics mode, enabling sine mode.

The query command will return 1 if the harmonics are applied, or 0 if the harmonics are inactive.

SOURce:PHASe<x>:VOLTage:MHARmonics:CLEar

This command clears all harmonics, except the fundamental associated with this phase's voltage. It does not have a query form.

SOURce:PHASe<x>:VOLTage:MHARmonics:AMPLitude(?) <dnpd>

This command sets the RMS value of the harmonic waveshape. Any harmonics will be scaled appropriately to keep the waveshape of the composite waveform the same. The query form returns the RMS value.

SOURce:PHASe<x>:VOLTage: MHARmonics: HARMonic<y> <dnpd>,<dnpd>

This command sets the specified phase's voltage channel harmonics for harmonic number **y** (0 to 100). DC is represented by harmonic number zero. The parameters specify amplitude (in the presently selected voltage amplitude units), and phase angle (in the presently selected phase angle units), respectively. The phase angle for the 0th harmonic (DC) must be zero.

SOURce:PHASe<x>:VOLTage:MHARmonics:HARMonic<y>? [<cpd>{ AMPLitude | PANGLE }]

This query returns the amplitude (in the presently selected voltage amplitude units), and phase angle (in the presently selected phase angle units) of the specified harmonic on the specified phase. Add the appropriate optional parameter to query just one of these values.

SOURce:PHASe<x>:VOLTage:MHARmonics:HARMonic<y>:AMPLitude?

This query returns the amplitude (in the presently selected Voltage amplitude Units of the specified harmonic on the specified phase.

SOURce:PHASe<x>:VOLTage:MHARmonics:HARMonic<y>:PANGLE?

This query returns the phase angle (in the presently selected phase angle units) of the specified harmonic on the specified phase.

SOURce:PHASe<x>:VOLTage:MHARmonics:ALL? [<cpd>{ AMPLitude | PANGLE }]

This query returns the amplitude (in the presently selected voltage amplitude units), and phase angle (in the presently selected phase angle units) of all harmonics on the specified phase as a comma separated list. Add the appropriate optional parameter to query just one of these values.

Example:

Suppose we have the following arrangement:

Harmonic	Amplitude	Phase
1	25.0V	90.0 deg
2	0.0V	0.0 deg
3	10.9V	0.0 deg
4	0.0V	0.0 deg
5	2.5V	165.0 deg

Expected responses:

```
:SOUR:PHAS:VOLT:HARM:ALL? "2.5E1,9.0E1,0.0E0,0.0E0,1.09E1,0.0E0,0.0E0,0.0E0,2.5E0,1.65E2"
:SOUR:PHAS:VOLT:HARM:ALL? AMPL "2.5E1,0.0E0,1.09E1,0.0E0,0.0E0,2.5E0"
:SOUR:PHAS:VOLT:HARM:ALL? PANG "9.0E1,0.0E0,0.0E0,0.0E0,1.65E2"
```

5-56. *Fluctuating Harmonics Phenomenon***SOURCE:PHASE<x>:VOLTage:FHARmonics:STATe(?) <bool>{OFF|ON|0|1}**

This command turns the specified phase's voltage channel fluctuating harmonics phenomena on and off. If no harmonics are currently selected for the specified phase, a suitable error message will be reported indicating that some harmonics need to be activated before fluctuation can be applied.

- ON or 1 will enable fluctuation of the phase's voltage harmonics.
- OFF or 0 will disable fluctuation of the phase's voltage harmonics.

The query command will return 1 if the specified fluctuation is being applied, or 0 if the specified fluctuation is inactive.

SOURCE:PHASE<x>:VOLTage:FHARmonics:CLEar

This command clears the modulation of harmonics associated with this phase's voltage. It does not have a query form.

SOURCE:PHASE<x>:VOLTage:FHARmonics:FLUCtuate<y>(?) <bool>{OFF|ON|0|1}

This command turns on/off the fluctuation of harmonic **y** on the Voltage channel of Phase **x**.

The query command will return 1 if the specified harmonic is being fluctuated, or 0 if the specified harmonic is not being fluctuated.

SOURCE:PHASE<x>:VOLTage:FHARmonics:ALL?

This query allows all the active harmonics to return their fluctuation state as a comma delimited string. The comma separated string will contain a value for each harmonic. Inactive harmonics will always cause 0 to be returned.

SOURCE:PHASE<x>:VOLTage:FHARmonics:MODulation <dnpd>,<dnpd>

This command sets the specified phase's voltage channel fluctuating harmonics modulation parameters. The first parameter is the modulation depth (expressed as a percentage of the voltage waveform RMS amplitude). The second parameter is the required modulation frequency (expressed in Hertz).

SOURCE:PHASE<x>:VOLTage:FHARmonics:MODulation? [<cpd>{DEPTH | FREQUENCY}]

This query returns the modulation depth and frequency for the Voltage channel of the specified phase. Add the appropriate optional parameter to query just one of these values.

SOURCE:PHASE<x>:VOLTage:FHARmonics:SHAPE(?) <cpd>{RECTangular|SINusoidal|SQUare}

This command selects the specified phase's voltage channel fluctuating harmonics modulation shape:

- RECT will set the modulation waveform to be rectangular.
- SIN will set the modulation waveform to be sinusoidal.
- SQU will set the modulation waveform to be square.

The query command will return SIN if the modulation shape is sinusoidal etc.

SOURce:PHASe<x>:VOLTage:FHARmonics:DUTY(?) <dnpd>

This command sets the specified phase's voltage channel fluctuating harmonics duty cycle value for rectangular modulation.

The query command will return the present duty cycle value. The returned number will be in standard scientific format (10.55 would be returned as 1.055E1).

5-57. *Interharmonics Phenomenon*

SOURce:PHASe<x>:VOLTage:IHARmonics:STATe(?) <bool>{OFF|ON|0|1}

This command turns the specified phase's voltage channel interharmonics phenomena on and off.

- ON or 1 will enable interharmonics on this phase's voltage channel.
- OFF or 0 will disable interharmonics on this phase's voltage channel.

The query command will return 1 if the interharmonics are enabled, or 0 if the interharmonics are disabled.

SOURce:PHASe<x>:VOLTage:IHARmonics:SIGNAL<y> <bool> {OFF|ON|0|1}[,<dnpd>,<dnpd>]

This command sets the specified inter-harmonics parameters. The <bool> parameter controls whether the inter-harmonic is active or not. The two optional <dnpd> parameters are numbers, which set the required amplitude (expressed in volts), and the required frequency (expressed in Hertz). <y> specifies the inter-harmonic to be set since the instrument is capable of producing 2 inter-harmonics simultaneously.

SOURce:PHASe<x>:VOLTage:IHARmonics:SIGNAL<y>? [<cpd>{STATe | AMPLitude | FREQuency}]

The default version of this query returns all of the settings of the specified Inter Harmonic, comma separated. Add the appropriate optional parameter to query just one of these values.

5-58. *Dip Phenomenon*

SOURce:PHASe<x>:VOLTage:DIP:STATe(?) <bool>{OFF|ON|0|1}

This command turns the specified Phase's Voltage channel Dip phenomena on and off.

- ON or 1 will set the specified Dip to be applied.
- OFF or 0 will set the specified Dip to be removed.

The query command will return 1 if Dip is applied, or 0 if Dip is inactive.

SOURce:PHASe<x>:VOLTage:DIP:ENVELOpe <dnpd>,<dnpd>,<dnpd>,<dnpd>,<dnpd>

This command sets the specified phase's voltage channel dip parameters:

- 1st dnpd - 'Change To' value (expressed as a percentage of total RMS voltage).
- 2nd dnpd - 'Ramp In' period (expressed in Seconds or Cycles).
- 3rd dnpd - 'Duration' (expressed in Seconds or Cycles).
- 4th dnpd - 'Ramp Out' period (expressed in Seconds or Cycles).
- 5th dnpd - 'End Delay' period (expressed in Seconds or Cycles).

SOURce:PHASe<x>:VOLTage:DIP:ENVELOpe? [<cpd>{CHANe | RIN | DURation | ROUT | EDELay}]

The default version of this query returns the dip envelope settings for the specified phase's voltage channel. Add the appropriate optional parameter to return a single value:

CHANge	Change To' value, expressed as a percentage of the total RMS Voltage
RIN	the 'Ramp In' period, expressed in Seconds or Cycles depending on the Dip Units setting
DURation	the 'Duration', expressed in Seconds or Cycles depending on the Dip Units setting
ROUT	the 'Ramp Out' period, expressed in Seconds or Cycles depending on the Dip Units setting
EDELay	the 'End Delay' period (expressed in Seconds or Cycles).

SOURce:PHASe<x>:VOLTage:DIP:TRIGger:INPut(?) <cpd>{ FREE | EONE | EREPeat}

This command sets and queries the trigger mode used to determine the event that starts the dip or swell:

- FREE is used for free running dips/swells.
- EONE is used to produce one dips/swell triggered from an external source.
- EREPeat is used to produce continuous dips/swells triggered from an external source.

SOURce:PHASe<x>:VOLTage:DIP:TRIGger:HOLDoff(?) <cpd>{PHASe|DELay},<dnpd>

This command selects sets and queries the hold-off before the dip/swell starts following a trigger.

PHASe	The hold-off is an angle following the trigger point. In this case the delay ,<dnpd>, has units of degrees or radians.
DELay	The hold-off is a time. In this case the delay ,<dnpd>, has units of seconds or cycles

SOURce:PHASe<x>:VOLTage:DIP:TRIGger:ODELay(?)<dnpd>

This sets and queries the delay (in seconds or cycles) before the output trigger is generated, following the completion of a dip or swell.

5-59. Flicker Phenomenon

SOURce:PHASe<x>:VOLTage:FLICKer:STATe(?) <bool>{OFF|ON|0|1}

This command turns the specified Phase's Voltage channel flicker phenomena on and off.

- ON or 1 will enable flicker on this phase's voltage channel.
- OFF or 0 will disable flicker on this phase's voltage channel.

The query command will return 1 if flicker is applied, or 0 if flicker is inactive.

SOURce:PHASe<x>:VOLTage:FLICKer:DEPTh(?) <dnpd>

This command sets the specified phase's voltage channel flicker modulation depth.

The <dnpd> is a number, which sets the required modulation depth, expressed as a percentage of the total RMS voltage signal.

The query version of this command will return the present modulation depth value. The returned number will be in standard scientific format (15.1% would be returned as 1.51E1).

SOURce:PHASe<x>:VOLTage:FLICKer:FREQuency(?) <dnpd>

This command sets the specified phase's voltage channel flicker modulation frequency. The <dnpd> is a number, which sets the required modulation frequency, expressed in Hertz.

The query command will return the present modulation frequency value. The returned number will be in standard scientific format (440.0Hz would be returned as 4.40E2).

SOURce:PHASe<x>:VOLTage:FLICKer:PST?

This query only command will return the present PST value. The returned number will be in standard scientific format (1.82 would be returned as 1.82E0).

SOURce:PHASe<x>:VOLTage:FLICKer:SHAPE(?)<cpd>{RECTangular|SINusoidal|SQUare}

This command selects the specified phase's voltage channel flicker modulation shape.

- RECT will set the modulation waveform to be rectangular.
- SIN will set the modulation waveform to be sinusoidal.
- SQU will set the modulation waveform to be square.

The query command will return SIN if the modulation shape is sinusoidal etc.

SOURce:PHASe<x>:VOLTage:FLICKer:DUTY(?) <dnpd>

This command sets the specified phase's voltage channel flicker duty cycle value for rectangular modulation.

The query command will return the present duty cycle value. The returned number will be in standard scientific format (10.55 would be returned as 1.055E1).

5-60. *Current Setup*

SOURce:PHASe<x>:CURRent:STATe(?) <bool>{OFF|ON|0|1}

This command turns the specified phase's current channel enabled or disabled.

- ON or 1 will enable the channel.
- OFF or 0 will disable the channel.

The query command will return 1 if output is on, or 0 if output is off.

SOURce:PHASe<x>:CURRent:RANGe <dpnd>,<dpnd>

This command sets the specified phase's current channel hardware range. The first parameter is the lower limit that the range must cover. The second parameter is the upper limit that the range must cover. The instrument determines the narrowest amplitude range that encompasses the limits.

For reference purposes, note that the following ranges are presently defined:

Range	Lower Limit	Upper Limit
0.25A range	0.05A	0.25A
0.5A range	0.05A	0.5A
1A range	0.1A	1A
2A range	0.2A	2A
5A range	0.5A	5A
10A range	1A	10A
21A range	2A	21A
80 A range	8 A	80 A

SOURce:PHASe<x>:CURRent:RANGe? [<cpd>{ LOW | HIGH }]

The default version will return the low and high limits of the presently selected range, comma separated. Add the appropriate optional parameter to query just one of these values.

SOURce:PHASe<x>:CURRent:RANGe:VOLTage <dpnd>,<dpnd>

This command sets the specified phase's current channel hardware range to output a voltage instead of a current. The first parameter is the lower limit that the range must cover. The second parameter is the upper limit that the range must cover. The instrument determines the narrowest amplitude range that encompasses the limits.

For reference purposes, note that the following ranges are presently defined:

Range	Lower Limit	Upper Limit
0.5V range	0.05V	0.25V
1V range	0.15V	1.5V
10V range	1V	10V

SOURce:PHASe<x>:CURRent:RANGe:VOLTage? [<cpd>{ LOW | HIGH }]

The default version will return the low and high limits of the presently selected range, comma separated. Add the appropriate optional parameter to query just one of these values.

SOURce:PHASe<x>:CURRent:RANGe:UNIT?

This query only command can be used to check whether the voltage out of current ranges are in use.

The response is:

- CURRent An ordinary current range is active.
- VOLTage A voltage out of current range is active.

SOURce:PHASe<x>:CURRent:AMPLitude?

This query only command is used to find out the specified phase's output amplitude, in RMS amps (or volts, if this mode is active).

The query command will return the present current value. The returned number will be in standard scientific format (14.4A would be returned as 1.44E1).

SOURce:PHASe<x>:CURRent:BANDwidth(?) [<cpd>{ NORMal | LOW }]

This command is used to select the current channel bandwidth limit.

- NORMAL a 6kHz limit is applied.
- LOW a 1.5 kHz limit is applied.

The query command will return the active setting.

Note: the *OPT? command reports whether bandwidth selection is available.

5-61. Harmonics Phenomenon

SOURce:PHASe<x>:CURRent:MHARmonic:STATe(?) <bool>{OFF|ON|0|1}

This command turns the specified phase's current channel harmonics phenomena on and off, toggling it with the Sine mode

- ON or 1 will enable harmonics mode, disabling Sine mode.
- OFF or 0 will disable harmonics mode, enabling Sine mode.

The query form returns the current state.

SOURCE:PHASE<x>:CURRENT:MHARmonics:CLEar

This command clears all harmonics, except the fundamental associated with this phase's Current. It does not have a query form.

SOURCE:PHASE<x>:CURRENT:MHARmonics:AMPLitude(?) <dnpd>

This command sets the RMS value of the harmonic waveshape. Any harmonics will be scaled appropriately to keep the waveshape of the composite waveform the same. The query form returns the RMS value.

SOURCE:PHASE<x>:CURRENT: MHARmonic:HARMonic<y> <dnpd>,<dnpd>

This command sets the specified phase's current channel harmonics for harmonic number *y* (1 to 100). The parameters specify amplitude (in the presently selected current amplitude units), and phase angle (in the presently selected phase angle units), respectively.

SOURCE:PHASE<x>:CURRENT:MHARmonic:HARMonic<y>? [<cpd>{ AMPLitude | PANGLE }]

This query returns the amplitude (in the presently selected current amplitude units), and phase angle (in the presently selected phase angle units) of the specified harmonic on the specified phase. Add the appropriate optional parameter to query just one of these values.

SOURCE:PHASE<x>:CURRENT:MHARmonics:HARMonic<y>:AMPLitude?

This query returns the amplitude (in the presently selected Current amplitude Units of the specified harmonic on the specified phase.

SOURCE:PHASE<x>:CURRENT:MHARmonics:HARMonic<y>:PANGLE?

This query returns the phase angle (in the presently selected phase angle units) of the specified harmonic on the specified phase.

SOURCE:PHASE<x>:CURRENT:MHARmonic:ALL? [<cpd>{ AMPLitude | PANGLE }]

This query returns the amplitude (in the presently selected current amplitude units), and phase angle (in the presently selected phase angle units) of all harmonics on the specified phase as a comma separated list. Add the appropriate optional parameter to query just one of these values.

Example, suppose we have the following arrangement:

Harmonic	Amplitude	Phase
1	2.5A	90.0 deg
2	0.0V	0.0 deg
3	1.09A	0.0 deg
4	0.0V	0.0 deg
5	0.25A	165.0 deg

Expected responses:

```
:SOUR:PHAS:CURR:HARM:ALL?           "2.5E0,9.0E1,0.0E0,0.0E0,1.09E0,0.0E0,0.0E0,0.0E0,0.0E0,2.5E-1,1.65E2"
:SOUR:PHAS:CURR:HARM:ALL? AMPL      "2.5E0,0.0E0,1.09E0,0.0E0,0.0E0,2.5E-1"
:SOUR:PHAS:CURR:HARM:ALL? PANG      "9.0E1,0.0E0,0.0E0,0.0E0,1.65E2"
```

5-62. *Fluctuating Harmonics Phenomenon*

SOURCE:PHASE<x>:CURRENT:FHARMONICS:STATE(?) <bool>{OFF|ON|0|1}

This command turns the specified phase's current channel fluctuating harmonics phenomena on and off. If no harmonics are currently selected for the specified Phase, a suitable error message will be reported indicating that some harmonics need to be activated before fluctuation can be applied.

- ON or 1 will enable fluctuation of this phase's current harmonics.
- OFF or 0 will disable fluctuation of this phase's current harmonics.

The query command will return 1 if the specified fluctuation is being applied, or 0 if the specified fluctuation is inactive.

SOURCE:PHASE<x>:CURRENT:FHARMONICS:CLEAR

This command clears the modulation of harmonics associated with this phase's current. It does not have a query form.

SOURCE:PHASE<x>:CURRENT:FHARMONICS:FLUCTUATE<y>(?)<bool>{OFF|ON|0|1}

This command turns on/off the fluctuation of harmonic **y** on the Current channel of Phase **x**.

The query command will return 1 if the specified harmonic is being fluctuated, or 0 if the specified harmonic is not being fluctuated.

SOURCE:PHASE<x>:CURRENT:FHARMONICS:ALL?

This query allows all the active harmonics to return their Fluctuation State as a comma delimited string. The comma separated string will contain a value for each harmonic. Inactive harmonics will always cause 0 to be returned.

SOURCE:PHASE<x>:CURRENT:FHARMONICS:MODULATION <dnpd>,<dnpd>

This command sets the specified phase's current channel fluctuating harmonics modulation parameters. The first parameter is the modulation depth (expressed as a percentage of the current waveform RMS amplitude). The second parameter is the required modulation frequency (expressed in Hertz).

SOURCE:PHASE<x>:CURRENT:FHARMONICS:MODULATION? [<cpd>{DEPTH | FREQUENCY}]

This query returns the modulation depth and frequency for the current channel of the specified phase. Add the appropriate optional parameter to query just one of these values.

SOURCE:PHASE<x>:CURRENT:FHARMONICS:SHAPE(?) <cpd>{RECTangular|SINusoidal|SQUare}

This command selects the specified Phase's Current channel fluctuating harmonics modulation shape.

- RECT will set the modulation waveform to be rectangular.
- SIN will set the modulation waveform to be sinusoidal.
- SQU will set the modulation waveform to be square.

The query command will return SIN if the modulation shape is sinusoidal etc.

SOURce:PHASe<x>:CURRent:FHARmonics:DUTY(?) <dnpd>

This command sets the specified Phase's Current channel fluctuating harmonics duty cycle value for rectangular modulation.

The query command will return the present duty cycle value. The returned number will be in standard scientific format (10.55 would be returned as 1.055E1).

5-63. *Interharmonics Phenomenon*

SOURce:PHASe<x>:CURRent:IHARmonics:STATe(?) <bool>{OFF|ON|0|1}

This command turns the specified phase's current channel interharmonics phenomena on and off.

- ON or 1 will enable interharmonics on this phase's current channel.
- OFF or 0 will disable interharmonics on this phase's current channel.

The query command will return 1 if the inter-harmonics are applied, or 0 if the inter-harmonics are inactive.

**SOURce:PHASe<x>:CURRent:IHARmonics:SIGNAL<y>
<bool>{OFF|ON|0|1}[,<dnpd>,<dnpd>]**

This command sets the specified interharmonics parameters. The <bool> parameter controls whether the inter-harmonic is active or not. The two optional <dnpd> parameters are numbers, which set the required amplitude (expressed in amps), and the required frequency (expressed in Hertz). <y> specifies the interharmonic to be set since the instrument is capable of producing 2 interharmonics simultaneously.

SOURce:PHASe<x>:CURRent:IHARmonic:SIGNAL<y>? [<cpd>{STATe | AMPLitude | FREQuency}]

The default version of this query returns all of the settings of the specified inter-harmonic, comma separated. Add the appropriate optional parameter to query just one of these values.

5-64. *Dip Phenomenon*

SOURce:PHASe<x>:CURRent:DIP:STATe(?) <bool>{OFF|ON|0|1}

This command turns the specified Phase's Current channel Dip phenomena on and off.

- ON or 1 will set the specified Dip to be applied.
- OFF or 0 will set the specified Dip to be removed.

The query command will return 1 if Dip is applied, or 0 if Dip is inactive.

**SOURce:PHASe<x>:CURRent:DIP:ENVELOpe
<dnpd>,<dnpd>,<dnpd>,<dnpd>,<dnpd>**

This command sets the specified Phase's current channel Dip parameters:

- 1st dnpd - 'Change To' value (expressed as a percentage of total RMS voltage).
- 2nd dnpd - 'Ramp In' period (expressed in Seconds or Cycles).
- 3rd dnpd - 'Duration' (expressed in Seconds or Cycles).
- 4th dnpd - 'Ramp Out' period (expressed in Seconds or Cycles).
- 5th dnpd - 'End Delay' period (expressed in Seconds or Cycles).

SOURce:PHASe<x>:CURRent:DIP:ENVELOpe? [<cpd>{CHANge | RIN | DURation | ROUT | EDELay}]

The default version of this query returns the Dip Envelope settings for the specified phase's current channel. Add the appropriate optional parameter to query just one of these values:

CHANge	'Change To' value, expressed as a percentage of the total RMS Voltage
RIN	the 'Ramp In' period, expressed in Seconds or Cycles depending on the Dip Units setting
DURation	the 'Duration', expressed in Seconds or Cycles depending on the Dip Units setting
ROUT	the 'Ramp Out' period, expressed in Seconds or Cycles depending on the Dip Units setting
EDELay	the 'End Delay' period (expressed in Seconds or Cycles).

SOURce:PHASe<x>:CURRent:DIP:TRIGger:INPut(?) <cpd>{ FREE | EONE | EREPeat}

This command sets and queries the trigger mode used to determine the event that starts the dip or swell.

- FREE is used for free running dips/swells.
- EONE is used to produce one dips/swell triggered from an external source.
- EREPeat is used to produce continuous dips/swells triggered from an external source.

SOURce:PHASe<x>:CURRent:DIP:TRIGger:HOLDoff (?) <cpd>{PHASe|DELay},<dnpd>

This command selects sets and queries the hold-off before the dip/swell starts following a trigger:

PHASe	The hold-off is an angle following the trigger point. In this case the delay ,<dnpd>, has units of degrees or radians.
DELay	The hold-off is a time. In this case the delay ,<dnpd>, has units of seconds or cycles.

SOURce:PHASe<x>:CURRent:DIP:TRIGger:ODELay(?)<dnpd>

This sets and queries the delay (in seconds or cycles) before the output trigger is generated, following the completion of a dip or swell.

5-65. Flicker Phenomenon

SOURce:PHASe<x>:CURRent:FLICKer:STATe(?) <bool>{OFF|ON|0|1}

This command turns the specified phase's current channel flicker phenomena on and off.

- ON or 1 will enable flicker on this phase's current channel.
- OFF or 0 will disable flicker on this phase's current channel.

The query command will return 1 if flicker is applied, or 0 if flicker is inactive.

SOURce:PHASe<x>:CURRent:FLICKer:DEPTh(?) <dnpd>

This command sets the specified phase's current channel flicker modulation depth.

The <dnpd> is a number, which sets the required modulation depth, expressed as a percentage of the total RMS current signal.

The query command will return the present modulation depth value. The returned number will be in standard scientific format (15.1% would be returned as 1.51E1).

SOURce:PHASe<x>:CURRent:FLICKer:FREQuency(?) <dnpd>

This command sets the specified phase's current channel flicker modulation frequency. The <dnpd> is a number, which sets the required modulation frequency, expressed in Hz.

The query command will return the present modulation frequency value. The returned number will be in standard scientific format (440.0Hz would be returned as 4 . 40E2).

SOURce:PHASe<x>:CURRent:FLICKer:PST?

This query only command will return the present PST value. The returned number will be in standard scientific format (1.82 would be returned as 1 . 82E0).

**SOURce:PHASe<x>:CURRent:FLICKer:SHAPE(?)
<cpd>{RECTangular|SINusoidal|SQUare}**

This command selects the specified phase's current channel flicker modulation shape.

- RECT will set the modulation waveform to be rectangular.
- SIN will set the modulation waveform to be sinusoidal.
- SQU will set the modulation waveform to be square.

The query command will return SIN if the modulation shape is sinusoidal etc.

SOURce:PHASe<x>:CURRent:FLICKer:DUTY(?) <dnpd>

This command sets the specified Phase's Current channel Flicker duty cycle value for rectangular modulation.

The query command will return the present duty cycle value. The returned number will be in standard scientific format (10.55 would be returned as 1 . 055E1).

5-66. Status Subsystem Command Details

This subsystem is used to enable bits in the Operation and Questionable Event registers. The Operation and Questionable: Event, Enable and Condition registers can be interrogated to determine their state.

STATus:OPERational [:EVENT]?

This command returns the contents of the Operation Event register, clearing the register.

The standard 6100A does not make use of this register, but additional hardware options do, (for example, the energy counter/timer option), see the option chapter for details.

STATus:OPERational:ENABle(?) <dnpd>

This command sets or returns the mask which enables those Operation Event register bits which are required to be summarized at bit 7 of the IEEE 488.2 Status Byte register.

STATus:OPERational:CONDition?

This query only command returns the contents of the Operation Condition register, which is not cleared by the command. N. B. This register contains transient states, in that its bits are not 'sticky', but are set and reset by the referred operations. The response to the query therefore represents an instantaneous 'Snapshot' of the register state, at the time that the query was accepted.

Normally the 6100A does not make use of this register, but future hardware options will, (for example, the energy counter/timer option), see the option chapter for details.

STATus:QUEStionable [:EVENT]?

The 6100A does not set any bits in this register.

This command returns the contents of the Questionable Event register, clearing the register.

STATus:QUEStionable:ENABle(?) <dnpd>

This command sets the mask which enables those Questionable Event register bits which are required to be summarised at bit 3 of the IEEE 488.2 Status Byte register.

STATus:QUEStionable:CONDition?

The 6100A does not set any bits in this register.

This query only command returns the contents of the Questionable Condition register which is not cleared by the command. N. B. This register contains transient states, in that its bits are not 'sticky', but are set and reset by the referred conditions. The response to the query therefore represents an instantaneous 'Snapshot' of the register state, at the time that the query was accepted.

STATus:PRESet

This is a SCPI mandated command. The intention behind mandating the STAT:PRESet command is to enable all bits in the SCPI defined 'device-dependent' and 'transition' registers in order to provide a "device-independent structure for determining the gross status of a device".

In the 6100A, the functions of the 'transition' registers are not required, so no access is given. The PRESet command therefore affects only the two device-dependent enabling registers:

- The Operation Event Enable register.
- The Questionable Event Enable register.

Sending STAT:PRESet will set true all bits in both Enable registers. This will enable all bits in the two Event registers, so that all reportable device-dependent events, reported in the two registers, will be capable of generating an SRQ; providing only that bits 3 and 7 in the IEEE 488.2 Status Byte Register are also enabled.

The use of STAT:PRESet in the 6100A allows the status-reporting structure to be set to a known state, not only for the intention of the SCPI mandate, but also to provide a known starting point for application programmers.

5-67. System Subsystem Command Details**SYSTEM:ERRor?**

As errors in the 6100A are detected, they are placed in a 'first in, first out' queue, called the 'Error Queue'. This queue conforms to the format described in the SCPI Command Reference (Volume 2), although errors only are detected. Three kinds of errors are reported in the Error Queue, in the sequence that they are detected:

Command errors, execution errors and device-dependent errors.

Queue Overflow

Any time the Error Queue overflows, the earliest errors remain in the queue, and the most recent error is discarded. The latest error in the queue is replaced by the error:

-350, "Queue overflow".

Purpose of SYST:ERR? — Reading the Error Queue

This query is used to return any error that has reached the head of the Error Queue, and delete the error from the queue. The Error Queue is first in / first out, so the returned string will represent the earliest error in the queue.

The queue is read destructively as described in the SCPI Command Reference to obtain a code number and error message. The query can be used successively to read errors in the queue until it is empty, when the message 0, "No Error" will be returned.

The response is in the form of 'String Program Data', and consists of two elements: a code number and error message.

SYSTem:DATE(?) <dnpd>,<dnpd>,<dnpd>

This command is used to change the date of the clock within the 6100A. The date format is YYYY, MM, DD

The Query will return the presently programmed date YYYY, MM, DD.

SYSTem:TIME(?)<dnpd>,<dnpd>

This command changes the present time as recorded by the 6100A. Any new time will be updated from a non-volatile real-time internal 24-hour clock.

A 24-hour clock format is used to set the time: HH, MM.

The Query will return the updated time at the moment the query was accepted as HH,MM,SS.

SYSTem:VERSion?

The query only command returns an <Nr2> formatted numeric value corresponding to the SCPI version number for which the 6100A complies. At the time of writing, this will be 1999.0.

5-68. Unit Subsystem Command Details

UNIT:ANGLE(?) <cpd>{DEGrees|RADIans}

This command sets the units to be used to express all instances of Phase Angle.

- DEG will set the phase angle units to be Degrees.
- RAD will set the phase angle units to be Radians.

The query command will return DEG if the units are set to Degrees, or RAD if the units are set to Radians.

UNIT:MHARmonics:CURRrent(?) <cpd>{PRMS|PFUN|DBF|ABS }

This command selects the specified harmonics amplitude units for current.

- PRMS will set the units to be 'Percentage of RMS Current' amplitude.
- PFUN will set the units to be 'Percentage of Fundamental' amplitude.
- DBF will set the units to be 'dB down from Fundamental' amplitude.
- ABS will set the units to be 'Absolute' value.

The query command will return PRMS if the units are set to 'Percentage of RMS Current', etc.

UNIT:MHARmonics:VOLTage(?) <cpd>{PRMS|PFUN|DBF|ABS}

This command selects the specified harmonics amplitude units for voltage.

- PRMS will set the units to be 'Percentage of RMS Voltage' amplitude.
- PFUN will set the units to be 'Percentage of Fundamental' amplitude.
- DBF will set the units to be 'dB down from Fundamental' amplitude.

- `ABS` will set the units to be 'Absolute' value.

The query command will return `PRMS` if the units are set to 'percentage of RMS voltage', etc.

UNIT:DIP:TIME(?) <cpd>{SECONDS|CYCLES}

This command selects the units used for time, when specifying dip parameters.

- `SEC` will set the Dip time units to be seconds.
- `CYCL` will set the Dip time units to be cycles.

The query command will return `SEC` if the Dip time units are set to seconds etc.

5-69. Common Commands and Queries

5-70. Clear Status

This measurement event status data structure conforms to the IEEE 488.2 standard requirements for this structure.



Figure 5-4. Clear Status

***CLS** clears all the event registers and queues except the output queue.

The output queue and MAV bit will be cleared if ***CLS** immediately follows a 'Program Message Terminator'; refer to the IEEE 488.2 standard document.

Execution Errors:

None.

Power On and Reset Conditions

Not applicable.

5-71. Event Status Enable

This event status data structure conforms to the IEEE 488.2 standard requirements for this structure.

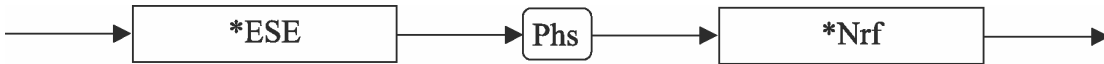

Figure 5-5. Event Status Enable

***ESE** enables the standard defined event bits, which will generate a summary message in the status byte.

Nrf is a Decimal Numeric Data Element representing an integer decimal value equivalent to the Hex value required to enable the appropriate bits in this 8 bit register. The detailed definition is contained in the IEEE 488.2 standard document. Note that numbers **will** be rounded to an integer.

Execution Errors:

None.

Power On and Reset Conditions

Not applicable.

5-72. Recall Event Status Enable

This event status data structure conforms to the IEEE 488.2 standard requirements for this structure.



Figure 5-6. Event Status Enable Query

Execution Errors:

None

Power On and Reset Conditions

The Power On condition depends on the condition stored by the common *PSC command if 0 then it is not cleared; if 1 then the register is cleared. Reset has no effect.

*ESE? recalls the enable mask for the standard defined events.

Response Decode:

The value returned, when converted to base 2 (binary), identifies the enabled bits which will generate a summary message in the service request byte, for this data structure. The detailed definition is contained in the IEEE 488.2 document.

5-73. Read Event Status Register

This event status data structure conforms to the IEEE 488.2 standard requirements for this structure.



Figure 5-7. Event Status Register Query

*ESR? recalls the standard defined events.

Response Decode:

The value returned, when converted to base 2 (binary), identifies the bits as defined in the IEEE 488.2 standard.

Execution Errors:

None

5-74. *IDN? (Instrument Identification)

This command conforms to the IEEE 488.2 standard requirements.



Figure 5-8. Instrument Identification

*IDN? will recall the instrument's manufacturer, model number, serial number and firmware level.

Response Format:

Character position

Fluke Ltd,6100A,XXXXXXXXXXXXX,X.XX

Where:

The data contained in the response consists of four comma-separated fields, the last two of which are instrument-dependent. The data element type is defined in the IEEE 488.2 standard specification.

Response Decode:

The data contained in the four fields is organized as follows:

- First field - manufacturer.
- Second field - model.
- Third field - serial number.
- Fourth field - firmware level (will possibly vary from one instrument to another).

Execution Errors:

None.

Power On and Reset Conditions

Not applicable.

5-75. Operation Complete

This command conforms to the IEEE 488.2 standard requirements.



Figure 5-9. Operation Complete

Execution Errors:

None.

Power On and Reset Conditions

Not applicable.

***OPC** is a synchronization command which will generate an operation complete message in the standard Event Status Register when all pending operations are complete.

5-76. Operation Complete?

This query conforms to the IEEE 488.2 standard requirements.



Figure 5-10. Operation Complete Query

Response Decode:

The value returned is always 1, which is placed in the output queue when all pending operations are complete.

5-77. Recall the instrument Hardware Fitment

This command conforms to the IEEE 488.2 standard requirements.



Figure 5-11. Option Query

***OPT?** recalls the instrument’s hardware configuration.

Response Format:

The data in the response consists of eight comma-separated values, one for each channel. These values are a binary weighted to indicate which options are fitted.

Response Decode:

The data element type is Nr1 as defined in the IEEE 488.2 standard specification.

A list of comma delimited Nr1 values represent the installed options per channel. This list is terminated by a newline with EOI character:

Phase 1 V, Phase 1 I, Phase 2 V, Phase 2 I, Phase 3 V, Phase 3 I, Neutral V, Neutral I

A bit weighted number represents the (optional) hardware included with a channel.

- Bit 0 80A current option has been fitted.
- Bit 1 Bandwidth current option has been fitted.
- Bit 2 Energy counter/timer option has been fitted.
- Bit 3-7 Unused

For example: a 6100A and a 6101A, the latter having 80A and bandwidth option would report

0,0,0,3,0,0,0,0

Execution Errors:

None.

Power On and Reset Conditions

Not applicable.

5-78. Power On Status Clear

This common command conforms to the IEEE 488.2 standard requirements.

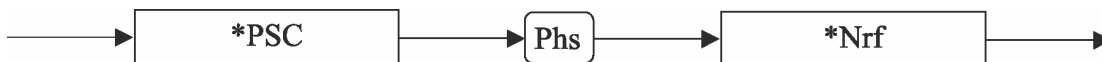

Figure 5-12. Power On Status Clear

***PSC** sets the flag controlling the clearing of defined registers at Power On.

Nrf is a decimal numeric value which, when rounded to an integer value of zero, sets the *power on clear flag* false. This allows the instrument to assert SRQ at power on, providing that the PON bit in the ESR is enabled at the time of power down, by the corresponding bit in its Enable register (ESE).

When the value rounds to an integer value other than zero it sets the *power on clear flag true*, which clears the standard *event status enable* and *service request enable* registers so that the instrument will not assert an SRQ on power up.

Examples:

*PSC 0 or *PSC 0.173 sets the instrument to **assert** an SRQ at Power On.

*PSC 1 or *PSC 0.773 sets the instrument to **not assert** an SRQ on Power On.

Execution Errors:

None.

Power On and Reset Conditions

Not applicable.

5-79. Recall Power On Status Clear Flag

This common query conforms to the IEEE 488.2 standard requirements. The existing flag condition will have been determined by the *PSC command.



Figure 5-13. Power On Status Clear Query

*PSC? will recall the Power On Status condition.

Response Format:

A single ASCII character is returned.

Response Decode:

The value returned identifies the state of the saved flag:

Zero indicates **false**. The instrument is not programmed to clear the Standard Event Status Enable Register and Service Request Enable Register at power PO, so the instrument will generate a 'power on' SRQ, providing that the PON bit in the ESR is enabled at the time of power-down, by the corresponding bit in its Enable register (ESE).

One indicates **true**. The instrument is programmed to clear the Standard Event Status Enable Register and Service Request Enable Register at power on, so the instrument cannot generate any SRQ at power on.

Execution Errors:

None

Power On and Reset Conditions

No change. This data is saved in non-volatile memory at power off, for use at power on.

5-80. Reset



Figure 5-14. Reset

***RST** will reset the instrument to a defined condition, stated for each applicable command with the command's description, and listed in *'Device Settings at Power On'*.

The reset condition is not dependent on past use history of the instrument except as noted below:

***RST** does not affect the following:

- The selected address of the instrument.
- Calibration data that affect specifications.
- SRQ mask conditions.
- The state of the IEEE 488.1 interface.

Execution Errors:

None.

Power On and Reset Conditions

Not applicable.

5-81. Service Request Enable

This Status Byte data structure conforms to the IEEE 488.2 standard requirements for this structure.

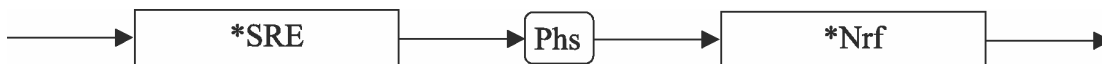

Figure 5-15. Service Request Enable

***SRE** enables the standard and user defined summary bits in the service request byte, which will generate a service request.

Nrf is a Decimal Numeric Data Element representing an integer decimal value equivalent to the Hex value required to enable the appropriate bits in this 8 bit register. The detail definition is contained in the IEEE 488.2 document.

Note that numbers **will** be rounded to an integer.

Execution Errors:

None.

Power On and Reset Conditions

Not applicable.

5-82. Recall Service Request Enable

This Status Byte data structure conforms to the IEEE 488.2 standard requirements for this structure.



Figure 5-16. Service Request Enable Query

***SRE?** recalls the enable mask for the standard defined events.

Response Decode:

The value returned, when converted to base 2 (binary), identifies the enabled bits that will generate a service request. The detail is contained in the IEEE 488.2 standard document.

Execution Errors:

None.

Power On and Reset Conditions

The Power On condition depends on the condition stored by the common ***PSC** command if 0 then it is not cleared. If 1 then the register is cleared. Reset has no effect.

5-83. Read Service Request Register

This Status Byte data structure conforms to the IEEE 488.2 standard requirements for this structure.

***STB?** recalls the service request register for summary bits.



Figure 5-17. Status Byte Query

Response Decode:

The value returned, when converted to base 2 (binary), identifies the summary bits for the current status of the data structures involved. For the detail definition see the IEEE 488.2 standard document. There is no method of clearing this byte directly. Its condition relies on the clearing of the overlying status data structure.

Execution Errors:

None.

Power On and Reset Conditions

Not applicable.

5-84. Test Operations — Full Selftest

This query conforms to the IEEE 488.2 standard requirements.



Figure 5-18. Test Query

***TST?** executes a Full selftest. A response is generated after the test is completed.

N. B. Operational selftest is valid only at temperatures: $23\text{ }^{\circ}\text{C} \pm 10\text{ }^{\circ}\text{C}$.

Response Decode:

The value returned identifies pass or failure of the operational selftest:

- **ZERO** indicates operational selftest complete with no errors detected.
- **Non zero** indicates operational selftest has failed. The number itself represents the number of test failures.

The failure codes can be found only by re-running the self-test manually.

Execution Errors:

Operational selftest is not permitted when calibration is successfully enabled.

Power On and Reset Conditions

Not applicable.

5-85. Wait

This command conforms to the IEEE 488.2 standard requirements.



Figure 5-19. Wait

***WAI** prevents the instrument from executing any further commands or queries until the *No Pending Operations Flag* is set true. This is a mandatory command for IEEE-488.2 but has little relevance to this instrument as there are no parallel processes requiring Pending Operation Flags.

Execution Errors:

None.

Power On and Reset Conditions

Not applicable.

5-86. Device settings after *RST

5-87. Introduction

*RST will reset the instrument to a defined condition, stated for each applicable command.

The reset condition is not dependent on past use history of the instrument except as noted below:

*RST does not affect the following:

- The selected address of the instrument.
- Calibration data that affect specifications.
- SRQ mask conditions.
- The state of the IEEE 488.1 interface.
- The Error Queue.
- The Power on Status Clear flag setting.
- The contents of:
 - The Status Byte Register.
 - The Status Byte Enable Register.
 - The Standard Event Status Register.
 - The Standard Event Status Enable Register.
 - The SCPI Operation Status Register.
 - The SCPI Operation Status Enable Register.
 - The SCPI Questionable Status Register.
 - The SCPI Questionable Status Enable Register.

*RST enforces the following states:

- The instrument is returned to 'Operation Complete Command Idle State' (OCIS).
- The instrument is returned to 'Operation Complete Query Idle State' (OQIS).

Settings Related to Common IEEE 488.2 Commands are as detailed in '*Common Commands and Queries*':

- The 'Enable Macro Command' (*EMC) is not used in the instrument.
- The 'Define Device Trigger Command' (*DDT) is not used in the instrument.
- Parallel Poll is not implemented in the instrument.

5-88. Device Settings at POWER ON

5-89. General

Active Mode: The instrument powers up in 'manual' mode.

Device I/D (Serial Number). Factory serial number preserved.

Status Reporting Conditions:

Status Byte Register.	Depends on state of *PSC.
Status Byte Enable Register.	Depends on state of *PSC.
Event Status Register.	Depends on state of *PSC.
Event Status Enable Register.	Depends on state of *PSC.
Operation Status Event Register.	Depends on state of *PSC.
Operation Status Enable Register.	Depends on state of *PSC.
Questionable Status Event Register.	Depends on state of *PSC.
Questionable Status Enable Register.	Depends on state of *PSC.
Error Queue.	Empty until first error is detected.

5-90. Power On Settings Related to Common IEEE 488.2 Commands

Program Coding	Condition
*CLS	Not applicable
*ESE Nrf	Not applicable
*ESE?	Response depends on state of *PSC
*ESR?	Response depends on state of *PSC
*IDN?	Not applicable
*OPC	Not applicable
*OPC?	Not applicable
*PSC	0/ 1 Not applicable
*PSC?	No change. This data is saved at power off for use at power on.
*PUD	Data area remains unchanged
*PUD?	Data area remains unchanged
*RST	Not applicable
*SRE Nrf	Not applicable
*SRE?	Response depends on state of *PSC
*STB?	Response depends on state of *PSC
*TST?	Not applicable
*WAI	Not applicable

5-91. *RST Settings Related to Common IEEE 488.2 Commands

Program Coding	Condition
*CLS	Not applicable
*ESE Nrf	Not applicable
*ESE?	Previous state preserved
*ESR?	Previous state preserved
*IDN?	No Change
*OPC	OPIQ state forced
*OPC?	OPIQ state forced
*OPT?	Not applicable
*PSC	0/ 1 Not applicable
*PSC?	No change.
*PUD	Data area remains unchanged
*PUD?	Data area remains unchanged
*SRE Nrf	Not applicable
*SRE?	Previous state preserved
*STB?	Previous state preserved
*TST?	Not applicable
*WAI	Not applicable

5-92. *RST Settings Related to SCPI Commands

Setting	Value following *RST
OUTPut	
:STATe	OFF
ROSCillator	
:STATe	OFF
:SENSe	Last set manually
:DEFer	
:STATe	OFF
SOURce	
:FREQuency	Last set manually
:LINE	OFF
:PHASe<x>	
:VOLTage	
:STATe	OFF
:RANGe	11,168
:AMPLitude	110
:MHARmonics	
:STATe	OFF
:HARMonic<y>	Harmonic 1 100% Harmonic 2 – 100 0%
:FHARmonics	
:STATe	OFF
:FLUCtuate<y>	Harmonic 1 – 100 OFF
:MODulation	Depth 0.0% Frequency 10.0 Hz
:SHAPE	SINusoidal
:IHARmonics	
:STATe	OFF
:SIGNal<y>	State OFF Amplitude 0.0% Frequency 33 Hz
:DIP	
:STATe	OFF
:ENVELOpe	Change to 10.0% Ramp In 0.0001 seconds Period 0.001 seconds Ramp Out 0.0001 seconds End Delay 0.0 seconds
TRIGger:	
INPut:	FREE
HOLDoff:	DEL, 0.0
ODELay:	0.0
:FLICKer	

Setting	Value following *RST
:STATe	OFF
:FREQuency	13.5 Hz
:DEPTh	0.402
:SHAPE	SQUare
:CURRent	
:STATe	OFF
:RANGe	0.1 1
:AMPLitude	0.5
:UNIT?	CURR
:MHARmonics	
[:STATe](?)	OFF
:HARMonic<y>	Harmonic 1 100%
	Harmonic 2 – 100 0%
:FHARmonics	
:STATe	OFF
:FLUCtuate<y>	Harmonic 1 – 100 OFF
:MODulation	Depth 0.0%
	Frequency 10.0 Hz
:SHAPE	SINusoidal
:IHARmonics	
:STATe	OFF
:SIGNal<y>	State OFF
	Amplitude 0.0%
	Frequency 33 Hz
:DIP	
:STATe	OFF
:ENVELOpe	Change to 10.0%
	Ramp In 0.0001 seconds
	Period 0.001 seconds
	Ramp Out 0.0001 seconds
	End Delay 0.0 seconds
TRIGger:	
INPut:	FREE
HOLDoff:	DEL, 0.0
ODELay:	0.0
:FLICKer	
:STATe	OFF
:FREQuency	13.5 Hz
:DEPTh	0.402
:SHAPE	SQUare
:UNIT	
:ANGLe	Last set manually
:MHARmonics	
:CURRent	Last set manually
:VOLTage	Last set manually

5-93. Worked examples

Examples summary:

- Example 1 Create a pure AC voltage signal.
- Example 2 Create an AC voltage signal with 2nd harmonic distortion.
- Example 3 Create an AC voltage signal with fluctuating 2nd harmonic distortion.
- Example 4 Create an AC current signal with flicker.
- Example 5 Create an AC voltage signal with multiple harmonic distortion and phase shifts.
- Example 6 Clear harmonics.
- Example 7 Create an AC multichannel signal.
- Example 8 Create an AC multiphase signal.
- Example 9 Create a pure DC voltage signal.
- Example 10 Create an AC voltage signal with a DC offset.
- Example 11 Create a pure DC voltage signal using SCPI tree-walked method.

Example 1.

Configure a master unit to output a sinusoidal signal of 60 Hz, 115 V RMS, containing no sub-harmonics or aberrations, and no phase shifts.

Setting UNIT:MHAR:VOLT (main harmonics units) to ABS (absolute) will allow the amplitude value to be entered directly in volts:

Reset all parameters to a known state.	*RST
Use abs units for voltage harmonics.	UNIT:MHAR:VOLT ABS
Setup Phase 1 (master) voltage range.	SOUR:PHAS1:VOLT:RANG 23,336
Fundamental amplitude and angle.	SOUR:PHAS1:VOLT:MHAR:HARM1 115,0
Setup the fundamental frequency.	SOUR:FREQ 60
Enable voltage output on this phase.	SOUR:PHAS1:VOLT:STAT ON
Set output to on (all phases).	OUTP:STAT ON

Example 2.

Configure a master unit to output a sinusoidal signal of 60 Hz, 115 V RMS, containing no aberrations, and no phase shifts.

Add a 2ND Harmonic component of 10 V RMS, 0° Phase angle to the waveform.

Reset all parameters to a known state.	*RST
Use abs units for voltage harmonics.	UNIT:MHAR:VOLT ABS
Setup Phase 1 (master) voltage range.	SOUR:PHAS1:VOLT:RANG 23,336
Fundamental amplitude and angle.	SOUR:PHAS1:VOLT:MHAR:HARM1 115,0

Set amplitude (in absolute units).	SOUR:PHAS1:VOLT:MHAR:HARM2 10,0
Setup the fundamental frequency.	SOUR:FREQ 60
Enable voltage output on this phase.	SOUR:PHAS1:VOLT:STAT ON
Set output to on (all phases).	OUTP:STAT ON

Example 3.

Fluctuate the 2nd Harmonic with a 25Hz, sinewave at 30% amplitude.

Ensure output is off.	OUTP:STAT OFF
Clear any modulation in progress.	SOUR:PHAS1:VOLT:FHAR:CLE
Select the harmonic to fluctuate.	SOUR:PHAS1:VOLT:FHAR:FLUC2 ON
Set fluctuation wave shape to sine.	SOUR:PHAS1:VOLT:FHAR:SHAP SIN
Set fluctuation.	SOUR:PHAS1:VOLT:FHAR:MOD 30,25
Enable fluctuating harmonics.	SOUR:PHAS1:VOLT:FHAR:STAT ON
Set output to on (all phases).	OUTP:STAT ON

Example 4.

In a similar way, a 1A, 60Hz Current Output with 20%, 25Hz Sinewave Flicker can be produced:

Reset all parameters to a known state.	*RST
Set units to absolute.	UNIT:MHAR:CURR ABS
Setup phase 1 (master) current range.	SOUR:PHAS1:CURR:RANG 0.2,2
Set amplitude (in absolute units).	SOUR:PHAS1:CURR:MHAR:HARM1 1,0
Setup frequency.	SOUR:FREQ 60
Set flicker wave shape to sine.	SOUR:PHAS1:CURR:FLIC:SHAP SIN
Set flicker frequency.	SOUR:PHAS1:CURR:FLIC:FREQ 25
Set flicker depth.	SOUR:PHAS1:CURR:FLIC:DEPT 20
Enable flicker.	SOUR:PHAS1:CURR:FLIC:STAT ON
Enable current output (phase 1).	SOUR:PHAS1:CURR:STAT ON
Set output to on (all phases).	OUTP:STAT ON

Example 5.

This example shows how to setup a fundamental and the 3rd and 5th harmonics.

The fundamental is set to 110V, 60Hz, the 3rd harmonic to 10V with 0° phase angle, and the 5th harmonic to 5V with a 90° phase angle.

Reset all parameters to a known state.	*RST
Ensure output is off.	OUTP:STAT OFF
Set units to absolute.	UNIT:MHAR:VOLT ABS
Setup frequency.	SOUR:FREQ 60
Setup phase 1 (master) voltage range.	SOUR:PHAS1:VOLT:RANG 23,336
Set amplitude (in absolute units).	SOUR:PHAS1:VOLT:MHAR:HARM1 110,0
Set amplitudes and phases of harm 3.	SOUR:PHAS1:VOLT:MHAR:HARM3 10,0
Set amplitudes and phases of harm 5.	SOUR:PHAS1:VOLT:MHAR:HARM5 5,90
Enable main harmonics.	SOUR:PHAS1:VOLT:MHAR:STAT ON
Enable voltage output (phase 1).	SOUR:PHAS1:VOLT:STAT ON
Set output to on (all phases).	OUTP:STAT ON

Example 6.

The harmonics in the previous example can be cleared before setting up new parameters so that they do not interfere with any new setup. This can be a useful approach, if a full *RST is not convenient.

Note: This will also clear the fundamental.

Clear all the harmonics.	SOUR:PHAS1:VOLT:MHAR:CLE
--------------------------	--------------------------

Example 7.

This example shows how to setup a 110 VRMS 60Hz voltage output from the voltage terminals and a 1A, 60 Hz current output from the current terminals. The current output lags the voltage output by 90°.

Reset all parameters to a known state.	*RST
Ensure Output is off.	OUTP:STAT OFF
Set voltage units to absolute.	UNIT:MHAR:VOLT ABS
Set current units to absolute.	UNIT:MHAR:CURR ABS
Setup frequency.	SOUR:FREQ 60
Setup phase 1 (master) voltage range.	SOUR:PHAS1:VOLT:RANG 23,336
Set Amplitude (in absolute units).	SOUR:PHAS1:VOLT:MHAR:HARM1 110,0
Setup phase 1 (master) current range.	SOUR:PHAS1:CURR:RANG 0.2,2
Set amplitude and phase.	SOUR:PHAS1:CURR:MHAR:HARM1 1,-90

Enable voltage output.	SOUR:PHAS1:VOLT:STAT ON
Enable current output.	SOUR:PHAS1:CURR:STAT ON
Set output to on (all phases).	OUTP:STAT ON

Example 8.

The previous example can be duplicated using a master unit to produce the voltage and an auxiliary unit to produce the current.

Reset all parameters to a known state.	*RST
Ensure output is off.	OUTP:STAT OFF
Disable voltage output (master).	SOUR:PHAS1:VOLT:STAT OFF
Disable current output (auxiliary).	SOUR:PHAS2:CURR:STAT OFF
Setup Frequency.	SOUR:FREQ 100
Setup phase 1 (master) voltage range.	SOUR:PHAS1:VOLT:RANG 23,414
Set amplitude (in absolute units).	SOUR:PHAS1:VOLT:MHAR:HARM1 110,0
Setup phase 2 (aux) current range.	SOUR:PHAS2:CURR:RANG 0.2,2
Set amplitude and phase.	SOUR:PHAS2:CURR:MHAR:HARM1 1,-90
Enable voltage output.	SOUR:PHAS1:VOLT:STAT ON
Enable current output.	SOUR:PHAS2:CURR:STAT ON
Set output to on (all phases).	OUTP:STAT ON

Example 9.

Configure a master unit to output a pure 5V DC signal. Note that as DC is treated by the 6100A as the 0th harmonic of a fundamental frequency, that frequency must be defined even when as in this case, the fundamental has zero amplitude.

Also note that previously enabled phenomena e.g., dip or interharmonic etc. would remain enabled if the *RST was not commanded.

Reset all parameters to a known state.	*RST
Use abs units for voltage harmonics.	UNIT:MHAR:VOLT ABS
Setup Phase 1 (master) voltage range.	SOUR:PHAS1:VOLT:RANG 1.1,16
Enable main harmonics (needed for DC).	SOUR:PHAS1:VOLT:MHAR:STAT ON
RMS amplitude (to remove fundemetal).	SOUR:PHAS1:VOLT:MHAR:AMPL 0
DC amplitude (will calculate new RMS).	SOUR:PHAS1:VOLT:MHAR:HARM0 5,0
Setup the fundamental frequency.	SOUR:FREQ 60
Enable voltage output on this phase.	SOUR:PHAS1:VOLT:STAT ON
Set output to on (all phases).	OUTP:STAT ON

Example 10.

Configure a master unit to output an AC signal of 60 Hz, 10 V RMS, with a 5V DC offset, containing no aberrations.

Reset all parameters to a known state.	*RST
Use % rms mode to easily calculate offset.	UNIT:MHAR:VOLT PRMS
Setup Phase 1 (master) voltage range.	SOUR:PHAS1:VOLT:RANG 1.1,16
Enable main harmonics (needed for DC).	SOUR:PHAS1:VOLT:MHAR:STAT ON
RMS amplitude (to remove fundemetal).	SOUR:PHAS1:VOLT:MHAR:AMPL 10
DC amplitude (will calculate new RMS).	SOUR:PHAS1:VOLT:MHAR:HARM0 50,0
Setup the fundamental frequency.	SOUR:FREQ 60
Enable voltage output on this phase.	SOUR:PHAS1:VOLT:STAT ON
Set output to on (all phases).	OUTP:STAT ON

Example 11.

This example creates the same output as example 9 (a pure 5V DC signal), but using SCPI tree walking, and avoiding *RST.

```
:FREQ 60;:UNIT:MHAR:VOLT ABS;:PHAS1:VOLT:RANG 1.1,16;STATE  
ON;MHAR:STAT ON;AMPL 0;CLE;HARM0 5,0;:OUTP ON
```

Chapter 6

Operator Maintenance

	Title	Page
6-1.	Introduction	6-3
6-2.	Confidence Test.....	6-3
6-3.	Setting up and running the Confidence Test.....	6-3
6-4.	Changing the user password.....	6-4
6-5.	Accessing the Fuse	6-4
6-6.	Cleaning the Air Filter.....	6-6
6-7.	Lithium Battery Replacement.....	6-8

6-1. Introduction

This chapter explains how to perform the routine user maintenance required to keep your 6100A Power Standard in optimal operating condition. The topics covered in this chapter include the following.

- Changing the user password
- Running the Confidence Test
- Replacing the fuse
- Cleaning the air filter and external surfaces

Calibration is discussed in chapter 7

6-2. Confidence Test

The Confidence Test provides an indication that instrument performance has not deteriorated significantly. The test for connected 6101A Auxiliary units is run from the 6100A Master instrument. The test is not designed to be used to determine service intervals as the measurements made are relatively crude compared with those that would be made at routine calibration and adjustment.

Note: Some temperature (Pic) tests may report percentage error of 100% but this is normal and should not be of concern

6-3. Setting up and running the Confidence Test

Navigate key to the Waveform menu with the Select Menu key. If necessary press ESC until the top level softkey menu is displayed, see figure 6-1.

Select Support Functions, Diagnostic tools, and enter the user password (see 6-4

The softkeys associated with the Self Test pop-up menu allow you to:

- Select which channels to test i.e., L1 Voltage, L1 Current ... N Current.
- Chose which channel sub-components to test, i.e., all boards, the DSP board, the control board or the first or second slave boards.
- Start the self test
- Save the test results to floppy disk.

Once the test required regime has been set up, press Start Self Test to initiate the test.

Remember, when navigating the various menus, the ESC key takes you up through the softkey hierarchy.

When the test is complete a summary report is presented in the Self Test menu.

The Test Pathway menu allows more detailed diagnosis of test results but this is essentially a tool provided for service centers. Although the Test Pathway facilities are available, a detailed description is not provided here as the technical content is beyond the scope of this manual.

6-4. Changing the user password

Navigate key to the Waveform menu with the Select Menu key. If necessary press ESC until the top level softkey menu is displayed.



Figure 6-1. Waveform menu top level softkeys

Select Support Functions, Diagnostic tools, and enter the user password. The default password when the 6100A is first shipped is “12321”.

Select Change Password to display the “change the calibration password...” pop-up menu. Enter the existing password, the new password and the new password again. Press Enter to change the password (or ESC to cancel the operation).

6-5. Accessing the Fuse

The power fuse is accessible from the rear panel.

⚠ WARNING

Before attempting to access the power fuse, ensure that the 6100A Electrical Power Standard is switched off at the rear mounted on/off switch and disconnected by removing the line power cord from the power input socket.

To access the fuse, proceed as follows:

1. Disconnect line power.
2. Using a standard screwdriver, turn the fuse holder counterclockwise until the cap and fuse are disengaged.

Always replace with the approved fuse shown below

Fluke part number and description:	1998159	T15AH 250V 32mm
Fuse manufacturer and part number:	Bussmann	MDA-15

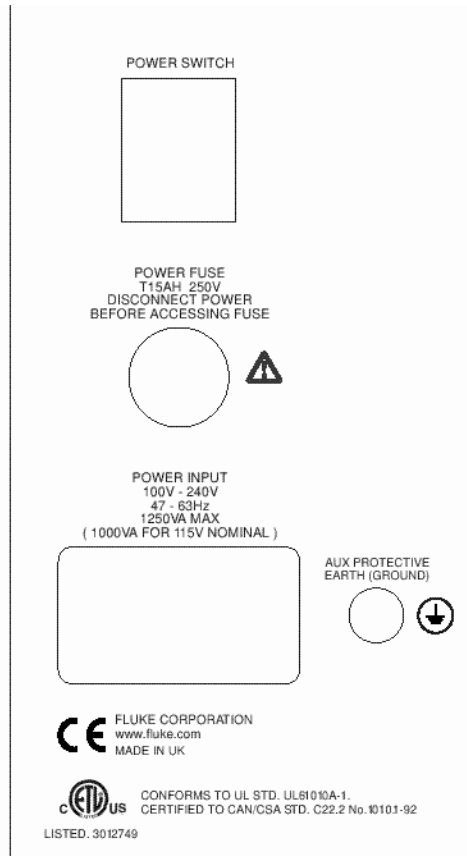

Figure 6-2. Rear Panel Showing Fuse

6-6. *Cleaning the Air Filter*

⚠ Caution

Damage caused by overheating may occur if the area around the fan is restricted, the intake air is too warm, or the air filter becomes clogged.

The air filter must be removed and cleaned at least every 30 days or more frequently if the 6100A Power Standard is operated in a dusty environment. The air filter is accessible from the rear panel of the 6100A Power Standard.

To clean the air filter, refer to Figure 7.2 and proceed as follows:

1. Disconnect line power.
2. The air filter is accessible from the rear of the unit. If the unit is sited on a bench, ensure that there is 24 inch clearance at the rear of the unit to allow you to withdraw the filter.
3. Remove the filter by unscrewing the 2 knurled screws at the top and the bottom of the vertical panel that secure the air filter. Pull the filter out of the unit.
4. Clean the filter by washing it in soapy water. Rinse and dry it thoroughly before reinstalling.
5. Reinstall the filter and tighten the knurled screws.

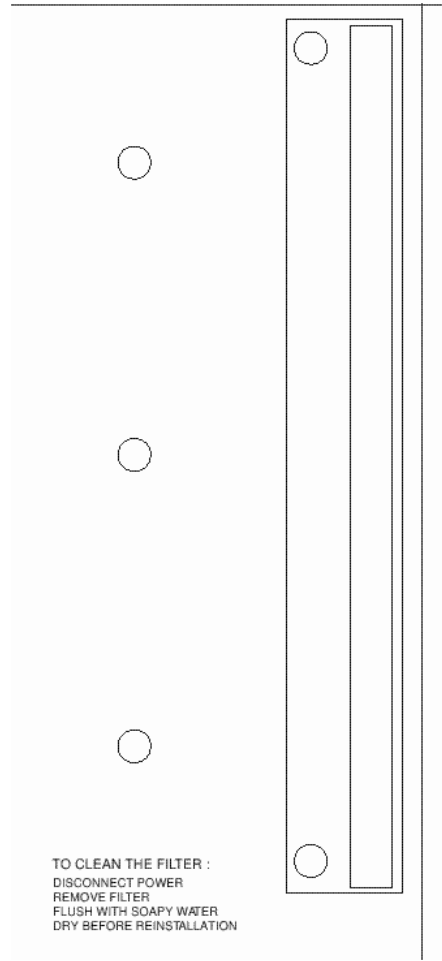

Figure 6-3. Air Filter Access

6-7. Lithium Battery Replacement

The PC within this instrument is fitted with a lithium battery (3V, 180mAH, CR2023 coin cell). Battery life should exceed 10 years. After this the PC setup and date information may be lost. The battery should be replaced with a UL approved equivalent by Fluke authorized technical personnel

Chapter 7

Calibration

	Title	Page
7-1.	Calibration methods.....	7-3
7-2.	Amplitude measurements.....	7-3
7-3.	Phase measurement.....	7-3
7-4.	The effect of phase uncertainty on power accuracy.....	7-3
7-5.	Calibration uncertainties for full accuracy.....	7-4
7-6.	Voltage amplitude calibration uncertainty required.....	7-4
7-7.	Current amplitude calibration uncertainty required.....	7-4
7-8.	Phase calibration uncertainty required.....	7-4
7-9.	Equipment required.....	7-5
7-10.	Overview of 6100A signal generation.....	7-6
7-11.	Independence of 6100A and 6101A.....	7-6
7-12.	The Fluke service center calibration system.....	7-8
7-13.	Characteristics of the calibration system.....	7-10
7-14.	Transducers.....	7-10
7-15.	DMM amplitude error contributions.....	7-10
7-16.	DMM amplitude phase contributions.....	7-10
7-17.	Voltage to voltage phase uncertainty.....	7-11
7-18.	Current to voltage phase uncertainty.....	7-11
7-19.	Overview of adjustment.....	7-12
7-20.	Calibration adjustment process.....	7-12
7-21.	Entering calibration mode.....	7-12
7-22.	Select instrument configuration.....	7-13
7-23.	Determine the 6100A/6101A error.....	7-14
7-24.	Initiate the adjustment.....	7-14
7-25.	Verification.....	7-14
7-26.	Calibration adjustment verification record.....	7-15
7-27.	Voltage adjustment points.....	7-15
7-28.	Current adjustment points.....	7-16
7-29.	Current adjustment points for 80A option (if fitted).....	7-17
7-30.	Voltage from current terminals adjustment points.....	7-17

7-1. Calibration methods

7-2. Amplitude measurements

Rigorous type testing of the 6100A has shown that when the phase and gain of each voltage or current channel are correctly adjusted, all other specifications will be met. Consequently, calibration of 6100A/6101A can be achieved with sinusoidal signals. Users should be aware however that the 6100A is optimized for use with sampling measurement instruments. Some RMS sensing meters have AC input bandwidths of many MHz and cannot reject non-harmonic components. As a result, this type of instrument may report amplitude values different from those obtained by sampling techniques. Sampling systems using Fourier Analysis have the advantage of extracting the signal of interest from noise and also yield accurate phase information.

7-3. Phase measurement

Potentially there are many ways of measuring amplitude and phase between Electrical Power Standard output channels. The amplitude of voltage and current can be determined independently but measurement of phase angle requires some form of comparison to be made. Comparing the current and voltage outputs of a 6100A with a zero crossing detection phase meter would provide phase information for that unit. But there are two disadvantages to this method.

- Comparison of the zero crossing of two signals is subject to noise at the zero crossing points; whereas sampling techniques get information from at least two points on the waveform.
- Measuring only the phase angle between voltage and current of a single unit does not allow independence of 6100A and 6101A calibration. Each 6101A auxiliary unit would need to be calibrated with its Master 6100A unit for voltage to voltage information.

If these disadvantages are acceptable for the calibration of a 6100A then phase uncertainties in the order of 0.050 degrees are possible with zero detection phase meters. Note that zero detection phase meters may give erroneous results in the presence of even harmonics because even harmonics can cause the zero crossing of a composite waveform to differ from the notional fundamental frequency zero crossing. . Sampling techniques, on the other hand, can give phase uncertainties as low as 0.0008 degrees and are not susceptible to other harmonics affecting the measurement.

7-4. The effect of phase uncertainty on power accuracy

As power = V.I.Cos(A), the contribution from phase angle accuracy can be shown with the following example:

If phase accuracy is $\pm 0.05^\circ$, at nominal PF = 0.5, Cos(A) could vary between Cos(59.95) and Cos(60.05) i.e., 0.5008 to 0.4992. This represents a range of

$$\frac{0.5008 - 0.4992}{0.5} * 100\% = 0.3\%$$

If Φ is the set phase angle and $u(\phi)$ is the phase accuracy, the general case of phase accuracy contribution to power accuracy $u(P)$ is given by:

$$u(P) = \left(1 - \frac{\cos(\Phi + u(\phi))}{\cos(\Phi)}\right) \times 100\%$$

Table 7-1 shows how phase uncertainty affects power accuracy at different power factors.

Phase uncertainty	PF = 1.0	PF = 0.75	PF = 0.5	PF = 0.25
0.0008°	±0.000%	±0.001%	±0.002%	±0.005%
0.050°	±0.000%	±0.077%	±0.151%	±0.338%

Table 7-1. The contribution of phase uncertainty to power accuracy

7-5. Calibration uncertainties for full accuracy

The uncertainties of measurement required to achieve the full specification of the 6100A are below. Lower accuracy equipment can be used but at the expense of 6100A accuracy. The calibration uncertainties stated are at 95% confidence probability.

7-6. Voltage amplitude calibration uncertainty required

	ppm of Range
1V to 1008 V, 16 Hz to 450 Hz	< 30
1V to 1008 V, 450 Hz to 6 kHz	< 120
1V to 1008 V, 6 kHz to 9kHz	< 1%

7-7. Current amplitude calibration uncertainty required

	ppm of Range
0.25 A to 5 A, 16 Hz to 450 Hz	< 33
5 A to 10A, 16 Hz to 450 Hz	< 40
10 A to 20 A , 16 Hz to 450 Hz	< 45
0.25 A to 10 A, 450 Hz to 6 kHz	< 125
10 A to 20 A , 450 Hz to 6 kHz	< 160
0.25 A to 20 A, 6 kHz to 9 kHz	< 1%

7-8. Phase calibration uncertainty required

Frequency	Phase measurement uncertainty	
	Current to voltage	Voltage to voltage
16 Hz – 69 Hz	0.0008°	0.002°
69 Hz – 180 Hz	0.0013°	0.005°
180 Hz – 450 Hz	0.0038°	0.014°
450 Hz – 3 kHz	0.0375°	0.098°
3 kHz – 6 kHz	0.0750°	0.195°

7-9. Equipment required

Two lists of equipment are provided, for two different methods of calibrating the 6100A. The “Fluke method” is used within the Fluke Service Centers, and has measurement uncertainties which support the full specifications of the 6100A

Two lists of equipment are provided. The alternative, non-Fluke service centre method will not achieve full 6100A specified accuracy, particularly for phase and power accuracy. You should perform your own uncertainty analysis if using alternative methods.

Measurement	Fluke method	Alternative
System control	MET/CAL®	Manual control or custom automation
Sampling	Fluke HP3458A/HFL with memory extension option in DC sampling mode. Additional analysis software	Sampling measurement device with appropriate analysis software
Voltage amplitude transducers	AC voltage divider set with small, known phase displacement errors	AC voltage dividers as required
Current amplitude transducers	AC current shunts with small, known phase displacement errors	AC current shunts as required
Voltage to phase reference signal phase angle	Derived from voltage amplitude measurements	Custom design or use voltage to current phase measurement
Current to phase reference signal phase angle	Derived from current amplitude measurements	Custom design or use voltage to current phase measurement
Voltage to current phase angle	Not required	Clarke-hess model 6000 phase meter or similar plus suitable shunts

Table 7-2. Calibration methods

7-10. Overview of 6100A signal generation

An overview of the 6100A signal generation system will aid further discussion off the Fluke method of calibration.

An Electrical Power Standard 'system' consists of a 6100A to provide a single phase of voltage and current plus up to three 6101A auxiliaries. The voltage and current channels are independent of each other for amplitude but are linked by a common internal 'Phase Reference' signal. Calibration adjustment of 6100A phase at manufacture is implemented independently on voltage and current channels by referring them to the 'Phase Reference'.

An understanding of the way the 6100A Electrical Power Standard generates its output signals will aid discussion of calibration methods.

7-11. Independence of 6100A and 6101A

Adding up to three 6101A Auxiliary units provides additional phases. Each 6101A Auxiliary stores its own calibration constants but is configured and calibrated via a 6100A. The 6100A Master unit provides its 'Phase Reference' signal to its 6101A Auxiliaries thus linking the phase of all output channels.

Because the phase of all signals is derived from the same, common Phase Reference, the calibration of a 6101A Auxiliary unit is independent of the 6100A Master unit controlling it.

The following describes the 6100A (L1) voltage channel. Unlike all other channels, the phase angle on the L1 voltage channel cannot be altered from zero except in calibration mode.

A digital representation of the requested output waveform is sampled, converted to an analogue signal and amplified. The 'D to A' conversion process and subsequent amplification introduces a phase shift and the output at the binding posts lags the digitally generated waveform. Figure 7-1 is a stylized representation of the relationship between the 'Phase Reference', the digitally sampled waveform and the analog output signal.

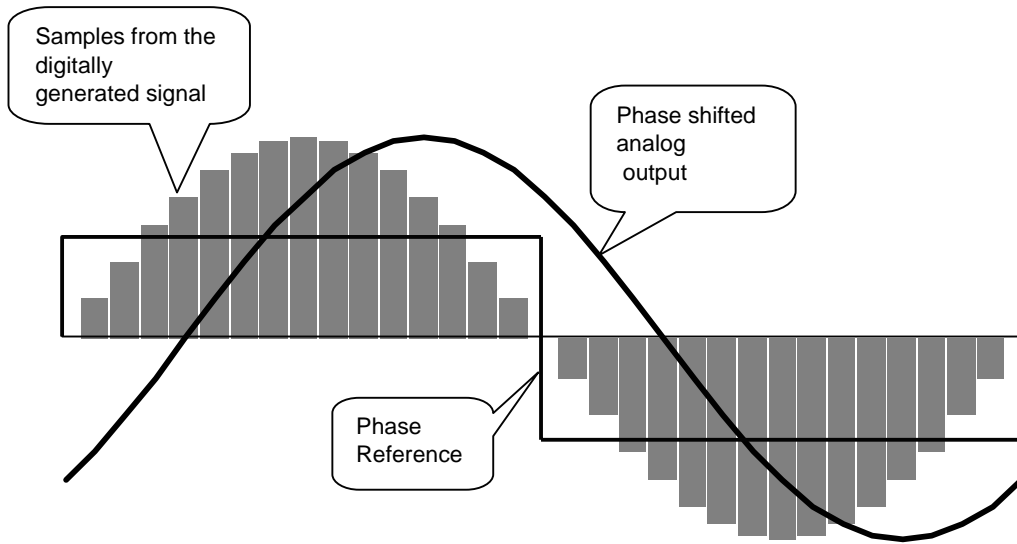

Figure 7-1. Signal generation

The objective of phase calibration adjustment is to remove the phase offset between the Phase Reference and the analogue output signal. Figure 7-2 shows the digitally sampled waveform phase shifted to align the analogue output to the Phase Reference. In practice there will be a small residual phase error determined by the accuracy of measurement.

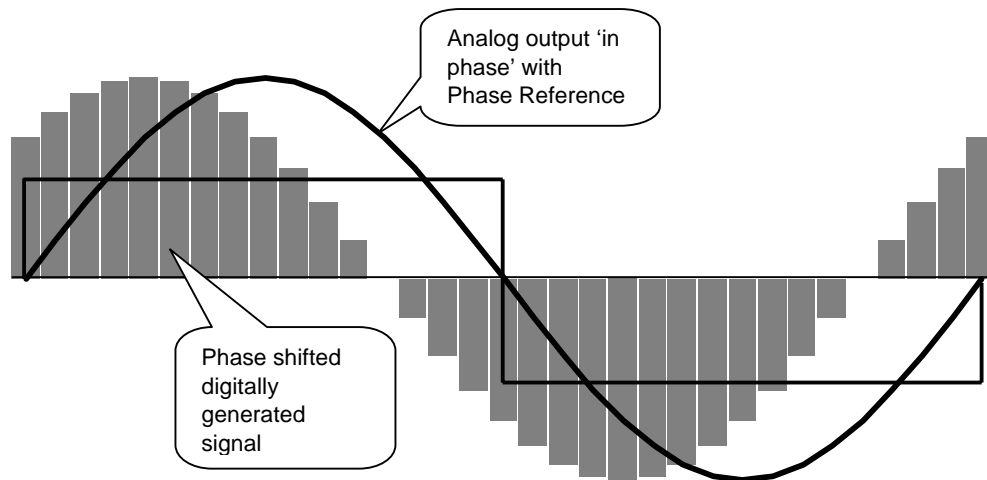

Figure 7-2. After phase adjustment

With the analogue signal of both voltage and current channels 'in phase' with the common Phase Reference, the phase relationship between voltage and current is known

with an uncertainty, which is the sum of the residual error from the voltage and current calibration adjustment.

The phase angles relative to the Phase reference of voltage channels other than L1 are nonzero by default. Nevertheless the same principle applies but with the phase angle between the analogue signal and the Phase Reference set to an appropriate nonzero value.

7-12. The Fluke service center calibration system

As described in section 7-11 above, the Fluke calibration system independently compares a voltage or current channel to the system phase reference. Fourier Analysis of sampled analogue signals yield amplitude and phase information which is used for calibration and adjustment. The digitizing DMM is triggered externally by a signal from the 6100A. The trigger signal, the Sample Reference, has a fixed phase relationship with the system Master Phase and controls that start of the sample period. Thus the phase relationship of the analogue signals is fixed to the phase reference and is known.

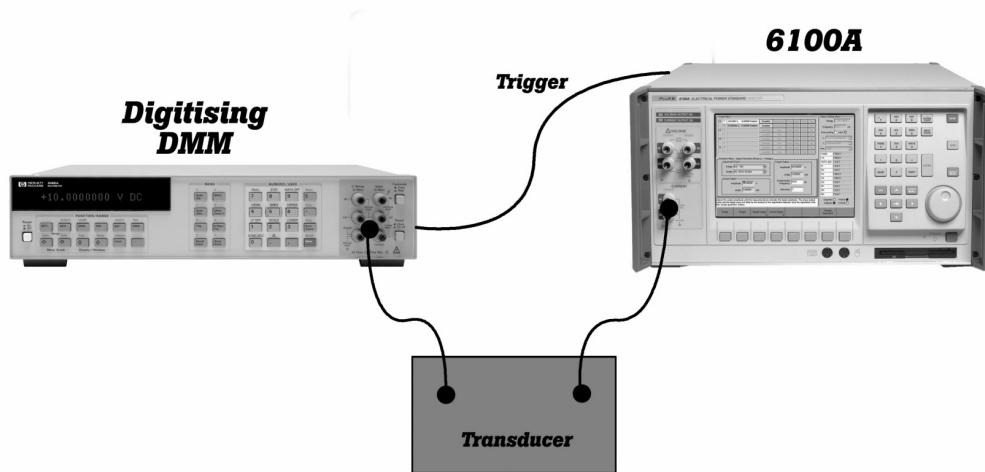

Figure 7-3. Phase Measurement Connections

Figure 7-3 shows how the 6100A, a digitizing DMM and transducer are connected. Note that voltage dividers and shunts are used to scale the input to the DMM for optimum performance. The same DMM is used to calibrate voltage and current.

The Sample Reference and the Phase Reference signals are provided on the 6100A rear panel. Figure 7-4 shows the relationship between reference signals and the analog output. The Sample reference is turned OFF and ON with GPIB commands. Sample Reference pulses do not appear after an ON command until the positive zero crossing of the Phase Reference occurs. Then the first falling edge is simultaneous with the Phase Reference rising edge. The DMM samples the analogue signal at each falling edge of the 'trigger' thereby phase-locking the sample to the analogue output.

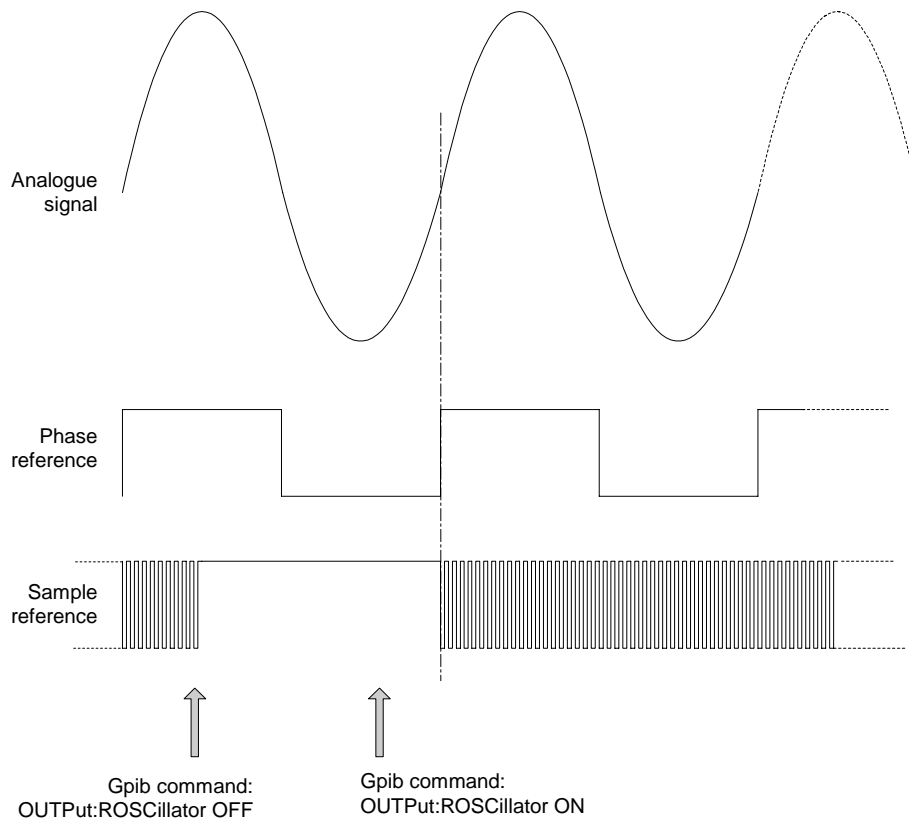

Figure 7-4. Waveforms

The system software programs the DMM to take the required number of samples so as long as the minimum required time is allowed to elapse, the timing of the sample reference 'off' command is not critical. The sample reference frequency is always a binary multiple of the analog fundamental frequency thereby simplifying the task of analyzing the sampled data.

7-13. Characteristics of the calibration system

Transducers are used to convert the different 6100A output voltage and current levels to nominally 800 mV. The DMM, a Fluke HP3458A/HFL with extended memory option is used on its 1.2 volt DC range for all measurements to reduce the relative phase uncertainty contribution from the DMM, i.e., errors in the DMM are the same for voltage and current. For each measurement the DMM is programmed to take 65,536 samples with an aperture of 1.4 μ s. At least 20% of the waveform contributes to each measurement minimizing variability due to noise. The system is automated with MET/CAL® software. Table 7-3 below shows samples per fundamental cycle and the minimum samples at the highest settable harmonic frequency.

6100A fundamental frequency (Hz)	Sample Reference pulses per fundamental cycle	Minimum samples per cycle at maximum harmonic frequency
16 to 32	2048	20
32 to 69	1024	10
69 to 128	512	5
128 to 256	256	5
256 to 512	128	5
512 to 850	64	5

Table 7-3. Samples per cycle

7-14. Transducers

The output from all transducers is 800mV RMS at full range. The switchable range voltage transducer is built into a system switching control unit to provide full automation. There are 6 voltage ranges each compensated by a parallel capacitive divider to compensate for stray capacitance and the input capacitance of the system DMM. Voltage divider phase uncertainty is typically 0.0002° at 60Hz, 0.002° at 1500Hz. Five special co-axial shunts are used with values of 0.5A, 2 A 10A, 20A and 80A.

The shunts are designed to exhibit mutual inductance of 0.5 nH \pm 0.5 nH. Shunts typically have phase displacement error uncertainty of 0.0003° at 60Hz and 0.013° at 1500Hz. Both voltage and current shunts exhibit temperature coefficients of less than 1 ppm/degree.

7-15. DMM amplitude error contributions

DMM gain and bandwidth contribute to amplitude error. These errors are calculated and combined with those of the transducers to provide amplitude corrections.

7-16. DMM amplitude phase contributions

The various phase error contributions of the DMM considerably exceed that of the transducers. Some of these contributions cancel for current to voltage phase measurements but not in voltage to voltage measurements for multiphase systems. The main systematic contributions to phase error from the DMM are bandwidth, aperture and

trigger delay. Table 7-4 shows the phase displacement uncertainties achieved in the Fluke system once DMM phase errors are compensated.

Frequency	Bandwidth Uncertainty	Trigger Uncertainty	Aperture Uncertainty	Combined uncertainty	Expanded Uncertainty (k = 2)
60 Hz	0.0004	0.0008	0.0000	0.0009	0.0018
6 kHz	0.0441	0.0786	0.0001	0.0901	0.1802

Table 7-4. DMM phase error uncertainty (degrees)

7-17. Voltage to voltage phase uncertainty

In Fluke service center systems errors are compensated by the application of corrections. The uncertainty due to the short-term stability of the DMM and measurement noise, plus the uncertainty due to voltage and current transducers must be combined with these values but these at typically 0.00023° are negligible. Thus the voltage to voltage phase calibration uncertainty for a 6100A and 6101A calibrated at different service centers will fall within the uncertainties estimated in Table 7-3 above

7-18. Current to voltage phase uncertainty

The phase of the current output of a 6100A or 6101A is specified relative to the voltage channel of the same instrument. By using the same DMM to measure both voltage and current against the common Sample Reference signal means all DMM related uncertainties other than short-term stability and measurement noise cancel. The remaining contributions (typically 0.00023°) are combined with transducer contributions giving a total expanded system uncertainty of 0.00049° for current to voltage phase.

7-19. Overview of adjustment

The steps required to calibrate at an adjustment point are enter the calibration mode then, for each calibration point:

- Select the instrument configuration required
- Determine the 6100A error by measurement
- Initiate the adjustment

Check the residual error is within acceptable limits and report the value to the calibration certificate.

7-20. Calibration adjustment process

The 6100A Electrical Power Standard can be adjusted in the software configuration. Select Support Functions/Adjust Instrument.



Figure 7-5. Waveform menu softkeys

7-21. Entering calibration mode



Figure 7-6. Password Prompt

The default password is “12321”. The password may be changed via the Change Password softkey (see chapter six). Any alpha numeric character available via the 6100A front panel can be used in passwords.

7-22. Select instrument configuration

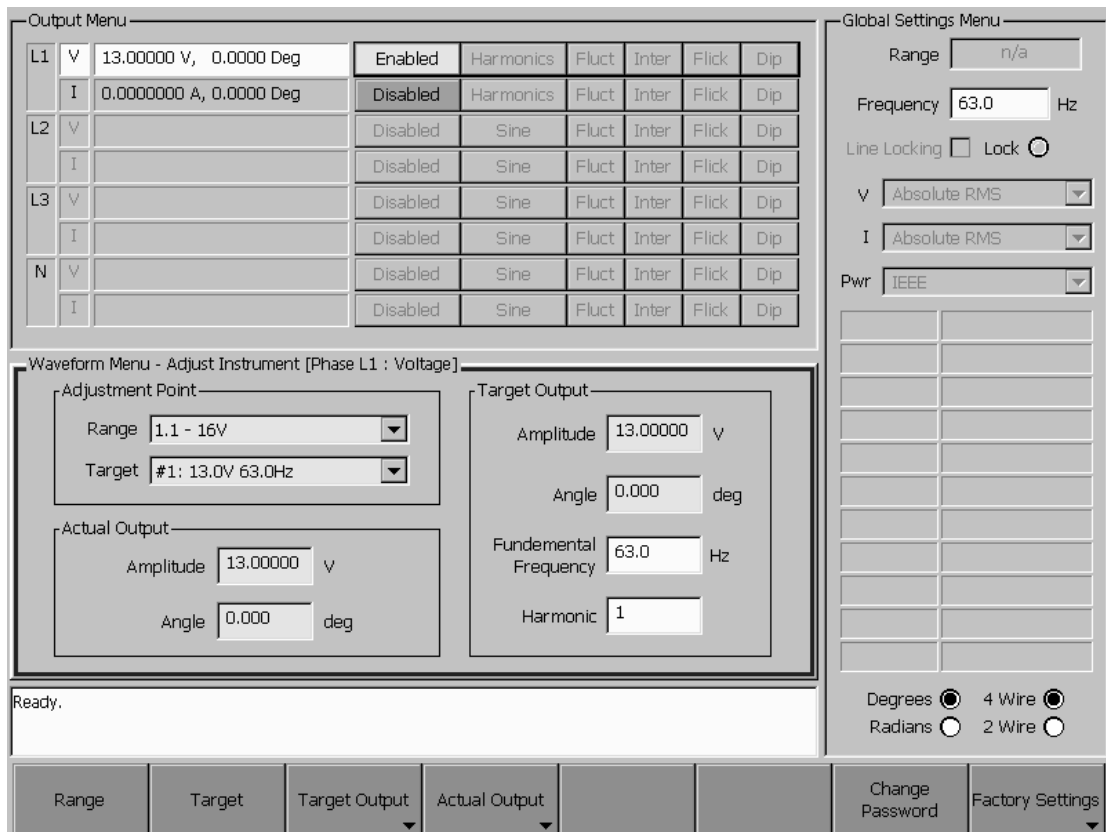

Figure 7-7. Adjust Instrument Screen

Select the instrument (L1, L2 etc.) and channel to be adjusted via the Output Menu

Select the required range

Select the required *Target*

For voltage calibration ensure 4-wire is selected.

Note that line locking is disabled when calibration mode is entered. The previous state is reinstated on exit from calibration mode.

7-23. Determine the 6100A/6101A error

Ensure the measurement equipment is correctly configured, connections are correctly made and turn the 6100A/6101A output on. After allowing the 6100A/6101A and measurement equipment time to settle, for each of the components to be adjusted:

Note the difference (D) between *Target* (T) and measured value (M): $D=T-M$

Calculate the required *Actual* value = $T+D$ (which is the same as $2T-M$)

Enter the *Actual* value in the *Actual* field

7-24. Initiate the adjustment

Press Accept adjustment

The 6100A/6101A instrument stores the amplitude and phase calibration constants.

After allowing the 6100A/6101A and measurement equipment time to settle:

If the residual errors are within limits, report the amplitude and phase values to the calibration certificate.

Otherwise, repeat the calibration adjustment process until the verification measurement results are within the required tolerance.

7-25. Verification

The following tables present 6100A contributions appropriate assuming the verification measurement is made within one hour of the adjustment with the same equipment and at the same temperature. The 6100 contribution is approximately the one-hour stability specification at $k=2$ (approximately 95% confidence). In the following tables, phase measurements are made as part of the amplitude measurements so the instrument amplitude settings are the same as for the associated amplitude measurement. The 95th harmonic amplitudes settings are outside the normal range for harmonics and can only be set in the calibration adjustment mode. Providing higher amplitudes in this special application maximises accuracy by reducing the effect of random noise.

It is suggested that the standard deviation of the measurement be added to the 6100A contribution to form the combined verification tolerance.

Note: because the calibration uncertainty of the reference standard is not included, the verification tolerance proposed is not the same as the uncertainty of the calibration.

7-26. Calibration adjustment verification record

7-27. Voltage adjustment points

Range (volts)	Frequency (Hz)	Harmonic number		Setting	6100A/ 6101A contribution	Measurement Std. Deviation	Combined verification tolerance (high)	Combined verification tolerance (low)	Result
1.1 – 16	0	0	DC offset		±0.9 mV				
1.1 – 16	63	1	Amplitude	13 V	±0.9 mV				
			Phase	0°	±0.0002°				
1.1 – 16	5985	95	Amplitude	13 V	±1.6 mV				
			Phase	0°	±0.001°				
2.3 – 33	0	0	DC offset		±1 mV				
2.3 – 33	63	1	Amplitude	26 V	±1.6 mV				
			Phase	0°	±0.0002°				
2.3 – 33	5985	95	Amplitude	26 V	±2.4 mV				
			Phase	0°	±0.001°				
5.6 – 78	0	0	DC offset		±1 mV				
5.6 – 78	63	1	Amplitude	65 V	±3.4 mV				
			Phase	0°	±0.0002°				
5.6 – 78	5985	95	Amplitude	65 V	±4.7 mV				
			Phase	0°	±0.001°				
11 – 168	0	0	DC offset		±0.004 mV				
11 – 168	63	1	Amplitude	130 V	±6.7 mV				
			Phase	0°	±0.0002°				
11 – 168	5985	95	Amplitude	130 V	±9.3 mV				
			Phase	0°	±0.001°				
23 – 336	0	0	DC offset		±0.008 mV				
23 – 336	63	1	Amplitude	260 V	±13.4 mV				
			Phase	0°	±0.0002°				
23 – 336	5985	95	Amplitude	200 V	±15 mV				
			Phase	0°	±0.001°				
70 – 1008	0	0	DC offset		±0.050 mV				
70 – 1008	63	1	Amplitude	800 V	±90 mV				
			Phase	0°	±0.0002°				
70 – 1008	5985	95	Amplitude	300 V	±55 mV				
			Phase	0°	±0.100°				

7-28. Current adjustment points

Range (Amps)	Frequency (Hz)	Harmonic number		Setting	6100A/ 6101A contribution	Measurement Std. Deviation	Combined verification tolerance (high)	Combined verification tolerance (low)	Result
0.05 – 0.25	0	0	DC offset		±10 µA				
0.05 – 0.25	63	1	Amplitude	0.2 A	±13 µA				
			Phase	0°	±0.0002°				
0.05 – 0.25	5985	95	Amplitude	0.2 A	±23 µA				
			Phase	0°	±0.001°				
0.05 – 0.5	0	0	DC offset		±20 µA				
0.05 – 0.5	63	1	Amplitude	0.4 A	±25 µA				
			Phase	0°	±0.0002°				
0.05 – 0.5	5985	95	Amplitude	0.4 A	±45 µA				
			Phase	0°	±0.001°				
0.1 – 1	0	0	DC offset		±40 µA				
0.1 – 1	63	1	Amplitude	0.8 A	±50 µA				
			Phase	0°	±0.0002°				
0.1 – 1	5985	95	Amplitude	0.8 A	±90 µA				
			Phase	0°	±0.001°				
0.2 – 2	0	0	DC offset		±80 µA				
0.2 – 2	63	1	Amplitude	1.6 A	±100 µA				
			Phase	0°	±0.0002°				
0.2 – 2	5985	95	Amplitude	1.6 A	±180 µA				
			Phase	0°	±0.001°				
0.5 – 5	0	0	DC offset		±200 µA				
0.5 – 5	63	1	Amplitude	4 A	±300 µA				
			Phase	0°	±0.0003°				
0.5 – 5	5985	95	Amplitude	4 A	±450 µA				
			Phase	0°	±0.001°				
1 – 10	0	0	DC offset		±400 µA				
1 – 10	63	1	Amplitude	8 A	±660 µA				
			Phase	0°	±0.0003°				
1 – 10	5985	95	Amplitude	8 A	±980 µA				
			Phase	0°	±0.002°				
2 – 21	0	0	DC offset		±2 mA				
2 – 21	63	1	Amplitude	16 A	±1.74 mA				
			Phase	0°	±0.0003°				
2 – 21	5985	95	Amplitude	16 A	±2.2 mA				
			Phase	0°	±0.002°				

7-29. Current adjustment points for 80A option (if fitted)

Range (Amps)	Frequency (Hz)	Harmonic number		Setting	6100A/ 6101A contribution	Measurement Std. Deviation	Combined verification tolerance (high)	Combined verification tolerance (low)	Result
8 – 0.80	63	1	Amplitude	64 A	±8 mA				
			Phase	0°	±0.0005°				
	2961	47	Amplitude	64 A	±11 mA				
			Phase	0°	±0.002°				

7-30. Voltage from current terminals adjustment points

Range (Volts)	Frequency (Hz)	Harmonic number		Setting	6100A/ 6101A contribution	Measurement Standard Deviation	Combined verification tolerance (high)	Combined verification tolerance (low)	Result
0.05 – 0.25	0	0	DC offset		±25 µV				
0.05 – 0.25	63	1	Amplitude	0.2 V	±25 µV				
			Phase	0°	±0.0002°				
0.05 – 0.25	5985	95	Amplitude	0.2 V	±35 µV				
			Phase	0°	±0.001°				
0.15 – 1.5	0	0	DC offset		±60 µV				
0.15 – 1.5	63	1	Amplitude	1.2 V	±80 µV				
			Phase	0°	±0.0002°				
0.15 – 1.5	5985	95	Amplitude	1.2 V	±145 µV				
			Phase	0°	±0.001°				
1 – 10	0	0	DC offset		±400 µV				
1 – 10	63	1	Amplitude	8 V	±520 µV				
			Phase	0°	±0.0002°				
1 – 10	5985	95	Amplitude	8 V	±950 µV				
			Phase	0°	±0.001°				

Chapter 8

The 'Energy' Option

	Title	Page
8-1.	Introduction	8-3
8-2.	Overview of functionality.....	8-3
8-3.	Principle of operation	8-3
8-4.	Limitations.....	8-3
8-5.	Energy specifications.....	8-4
8-6.	Pulse Inputs	8-4
8-7.	Pulse and Gate Inputs.....	8-4
8-8.	Pulse Output	8-4
8-9.	Gate Output	8-4
8-10.	Accuracy	8-4
8-11.	Test Duration.....	8-4
8-12.	Preparing to use the energy option	8-5
8-13.	Input channel configuration and meter constants.....	8-6
8-14.	Connect MUT and reference meters	8-6
8-15.	'Type' of energy	8-6
8-16.	Internal Pull-ups	8-6
8-17.	Energy Pulse Output meter constant and pull-up.....	8-7
8-18.	Conduct the test.....	8-7
8-19.	Test modes	8-7
8-20.	Free Run mode	8-8
8-21.	Counted/Timed mode	8-8
8-22.	Gated mode	8-9
8-23.	Packet mode	8-9
8-24.	Remote operation of the Energy option.....	8-10
8-25.	SCPI command set.....	8-10
8-26.	Operating mode	8-10
8-27.	Energy units	8-10
8-28.	Result presentation	8-11
8-29.	Results	8-11
8-30.	Output gating.....	8-11
8-31.	Input gating	8-12
8-32.	Warm-up sequence tree.....	8-12
8-33.	Warm-up duration	8-13
8-34.	Warm-up pulse source.....	8-13

8-35.	Test sequence tree	8-13
8-36.	Test duration	8-13
8-37.	Test pulse source	8-13
8-38.	MUT tree	8-14
8-39.	MUT meter constant	8-14
8-40.	MUT source	8-14
8-41.	MUT pull-up	8-14
8-42.	Reference tree	8-15
8-43.	Reference meter constant	8-15
8-44.	Reference source	8-15
8-45.	Reference pull-up	8-15
8-46.	Output tree.....	8-15
8-47.	Output meter constant	8-15
8-48.	Output pull-up	8-16
8-49.	Status subsystem	8-16
8-50.	Status operational Tree	8-16
8-51.	Operation event	8-16
8-52.	Operational enable	8-16
8-53.	Operation condition.....	8-17
8-54.	Energy Command Summary	8-17
8-55.	Action on receiving *RST.....	8-18
8-56.	Calibration of the Energy option	8-20
8-57.	By direct measurement with a frequency meter:.....	8-20
8-58.	Using an external reference frequency:	8-20

8-1. Introduction

This chapter describes the 6100A Power Standard 'Energy' option. The topics covered in this chapter include the following:

- The Energy option specifications
- Front panel operation of the Energy option
- Remote operation of the Energy option
- Calibration of the Energy option

8-2. Overview of functionality

Meters supply a stream of pulses of a frequency proportional to the power being applied to their voltage and current input terminals. The total pulses represent the total energy delivered. The 6100A has six pulse inputs which can be configured for combinations of Meters Under Test (MUT) and reference meters. The 6100A also provides an output stream of pulses, representing the calculated theoretical output power of the system, to provide an 'ideal' pulse stream reference. A gate signal is available to switch external equipment during a test, or for the user to electronically control the duration of the test. The Energy Pulse Output and Energy Gate In/Out BNC connectors are mounted on the 6100A rear panel.

8-3. Principle of operation

One or more MUT are connected to the 6100A, or a 6101A auxiliary unit, voltage and current terminals. A test is conducted which involves counting the number of pulses received within a specified period. The result is compared with the theoretical amount of energy delivered, or against a reference source which was connected in parallel to the MUT. The duration of the test is set by specifying a limit condition, which can be an absolute time, an amount of energy delivered, or as an accumulated energy from any MUT or reference meter channel (expressed as energy or pulse count). Input channels can be combined to allow three per-phase pulse streams to represent a three-phase source, or to enable up to three reference meters to be averaged.

8-4. Limitations

The 6100A is an accurate reference source for independent voltage and current and 'phantom power'. Unlike power supplies, the 6100A and 6101A have a closed loop feedback system to ensure that the output waveforms are always of the demanded form. Extremely non-linear loads such as the power supply of electronic meters disrupt the 6100A and 6101A ability to maintain the correct output state. Attempting to provide line power to energy meters from the 6100A system may cause the 6100A and 6101A output to trip or result in inaccurate readings. Always connect the meter's auxiliary power supply to a suitable external power source. The 6100A and 6101A output capabilities are described in the specifications in Chapter 1.

The 6100A computed theoretical output power is accurate in Sine and Harmonic modes. Adding Flicker, Dips, Fluctuating Harmonics or Interharmonics will reduce the accuracy of the output power calculation and hence calculation of MUT error. If a reference meter is used, measurement accuracy depends on the performance of the reference meter for nonsinusoidal and amplitude modulated signal inputs.

8-5. Energy specifications

8-6. Pulse Inputs

Max frequency	5MHz
Min pulse width	60ns
Max counts per channel	$2^{32}-1$ (4,294,967,295)

8-7. Pulse and Gate Inputs

Input Low level max	1V
Input High level min	3V
Internal pull-up values	135Ω and 940Ω to 4.5V nominal (Approximately equivalent to 150Ω/1kΩ to 5V nominal)
Max input voltage	28V (clamped @ 30V approximately) [1]
Min input voltage	0V (clamped @ -0.5V approximately) [1]

8-8. Pulse Output

Drive	Open-collector with optional internal 470Ω pull-up
Frequency range	0.011Hz – 5MHz
Frequency accuracy	$\pm(50\text{ppm} + 107\text{nHz})$
External pull-up voltage	30V MAX (clamped) [1]
Sink current	150mA MAX

8-9. Gate Output

Drive	Open-drain
Internal Pull-up	As Gate-Input
External pull-up voltage	30V MAX (clamped) [1]
Sink current	1A MAX

[1] Input/Output protection: 30V / -0.5V (approximately) clamped, up to 120mA per signal or 300mA max total all signals.

8-10. Accuracy

Counted/Timed timing accuracy	$\pm(50\text{ppm} + 60\text{ns})$
Packet mode accuracy (ppm)	$\pm(\text{output power (ppm)} + 50\text{ppm} + 101,000/\text{Test Duration (secs)})$

When very low pulse input rates are used (<1Hz) the instantaneous power and frequency displays may be unstable and/or have poor resolution. However, the accumulated energy or counts are always accurate.

8-11. Test Duration

Maximum test duration	2500 hours
-----------------------	------------

8-12. Preparing to use the energy option

Set the voltage and current output combinations for L1 (and L2 and L3) as required for the test. See chapters three and four for front panel operating instructions. *Enable* the channels that will be used but do not turn the outputs on.

To enter the Energy mode, navigate to the Waveform Menu. Press escape until the top level softkey menu is displayed as shown in Figure 8-1.



Figure 8-1. Waveform menu top level softkeys

Press the Energy Counting softkey to enter the Energy mode. Figure 8-2. Energy mode shows the interface which overlays the Waveform menu. See paragraph 8-19 for a description of the test modes available.

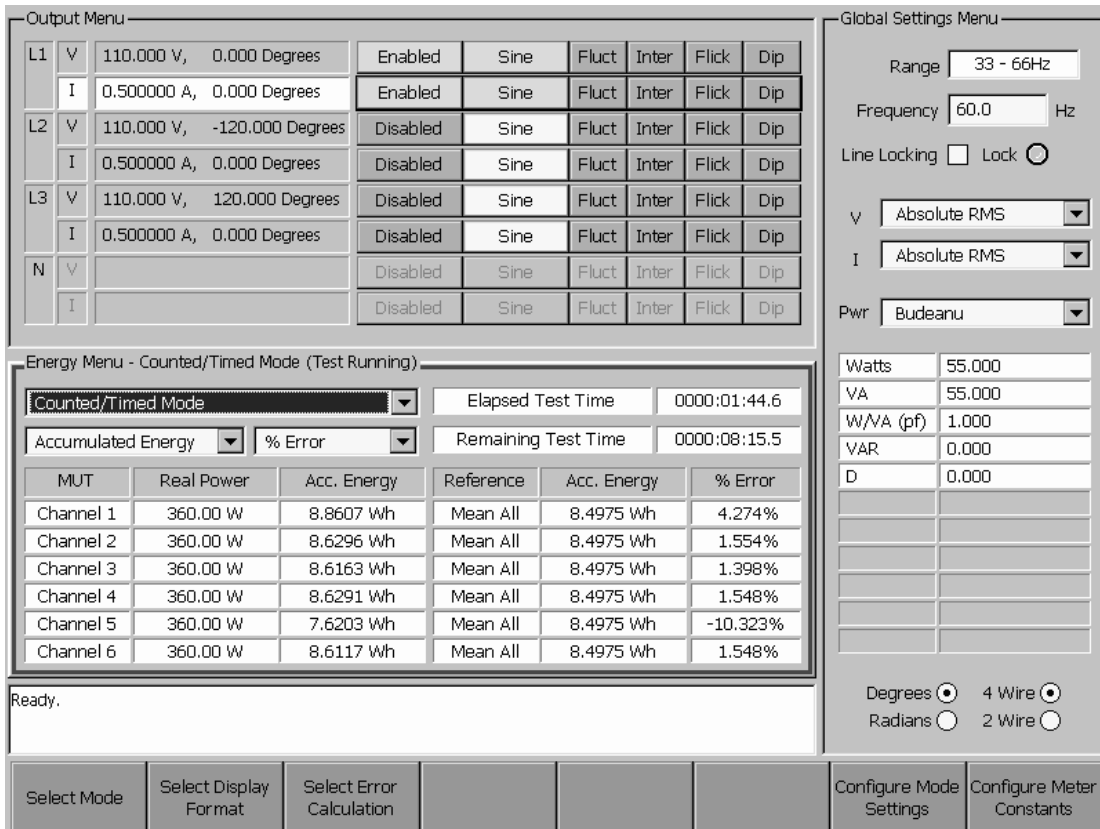

Figure 8-2. Energy mode

8-13. Input channel configuration and meter constants

The system first must be configured to the required MUT and reference meter set-up. Press the Configure Meter Constants softkey to access the configuration options.

The screenshot shows a configuration window titled "Channel Configuration and Meter Constants". It contains several sections for setting up input channels and meter constants. The "MUT Source" section has radio buttons for various channel combinations, with "Channel 1 to 6 (independent)" selected. The "Reference Source" section has radio buttons for "Main Output" and other channel-based options, with "Mean of all MUT channels" selected. The "Meter constant base units" is set to "Real (Wh)". The "Meter Constant (MUT)" section has a dropdown set to "i / Wh" and a text box with "100000". The "MUT Internal Pull-up" section has radio buttons for "150 Ω" and "1 kΩ", with "1 kΩ" selected. The "Meter Constant (Reference)" section has a dropdown set to "i / Wh" and a text box with "100000". The "Ref Internal pull-up" section has radio buttons for "150 Ω" and "1 kΩ", with "1 kΩ" selected. The "Meter Constant (Output)" section has a dropdown set to "i / Wh", a text box with "100000", and a checkbox for "Use Internal pull-up" which is unchecked.

Figure 8-3. Input channel configuration and meter constants

8-14. Connect MUT and reference meters

Connect the MUT to channel(s) starting at the lowest numbered channel and working up. For example, three MUT would connect to channels 1, 2 & 3. If reference meters are used they should be connected starting at the highest numbered channel and working down. For example, a single reference meter would be on channel 6. Select the combination of MUT and reference meters that you require from the lists on the left of the configuration dialog. If Main Output is selected as the reference, MUT will be compared against the Pulse Out signal that represents the theoretical energy output of the system.

8-15. 'Type' of energy

It is necessary to set the type of energy being measured in the test: Real (Wh), Effective (VAh) or Reactive (VARh). This setting should match the settings on the MUT and reference meter(s). The meter constants then need to be specified. There is one value for all MUT and one for all reference meters.

8-16. Internal Pull-ups

Each input group (MUT and Reference) may have either 150Ω or 1kΩ pull-ups internal to the 6100A. It is recommended that 150Ω be used where possible for higher frequency pulse rates.

8-17. Energy Pulse Output meter constant and pull-up

A value can be set which specifies the effective meter constant of the Pulse Out connector. Whenever an Energy test is active this output is a pulse stream representing the total power and energy of the active V/I outputs of all 6100A/6101A in the system.

A user selectable internal pull-up is provided for the Energy Pulse Output. The Use Internal Pull-up check box selects and deselects this pull-up. The pull-up should remain deselected (not checked) unless the device connected to the Energy Pulse Output does not provide a pull-up.

8-18. Conduct the test

Press Enter to accept the newly defined values, or Escape to cancel all changes.

Pressing the OPER key starts the test. At this point the voltage and current source main output terminals become active. The user cannot leave (ESC) the Energy screen while the test is active. To abort the test, press the STBY key.

During the test the Energy screen will display rows of numbers corresponding to the user channel configuration. Pulse rate and total pulses are displayed, either as power and energy or as frequency and count depending on the Display Units setting. The accumulated total is compared with the specified reference source and an error or registration percentage is displayed. These display parameters can be changed 'on the fly' by pressing the corresponding softkey to activate the list box and changing the value with the cursors. Time elapsed and time remaining (where known) for the test is also displayed. Time remaining may be an estimate for some mode combinations.

8-19. Test modes

There are four test modes available.

Select Mode	Select Display Format	Select Error Calculation				Configure Mode Settings	Configure Meter Constants
-------------	-----------------------	--------------------------	--	--	--	-------------------------	---------------------------

Figure 8-4. Energy top level softkeys

To change mode, press the Select Mode softkey, then cycle through the available modes using the up/down cursor keys. In each case the parameters for the test can be changed in the configuration dialog for the currently selected mode by pressing the Configure Mode softkey.

8-20. Free Run mode

In Free Run mode, power is applied to the MUT and a running tally is kept of the pulses received from each. The test will continue until the user aborts the test. This mode is only intended to offer approximate comparisons of performance, but might for example be used to monitor a MUT during adjustment, or for creep tests.

8-21. Counted/Timed mode

The purpose of the Counted/Timed mode is to allow measurements to be made when both the 6100A and MUT are fully stabilized after warm-up and the 6100A output has settled after the output is turned on. The minimum warm-up time is 2 seconds.

In this mode the source power is applied to the MUT immediately when the OPER key is pressed but the comparison of counts does not start until the specified warm-up period has expired. Both the warm-up and test duration can be specified freely as time or energy or counts on any configured channel. If warm-up is specified in energy counts it is important to ensure the number of counts specified is equivalent to at least 2 seconds.

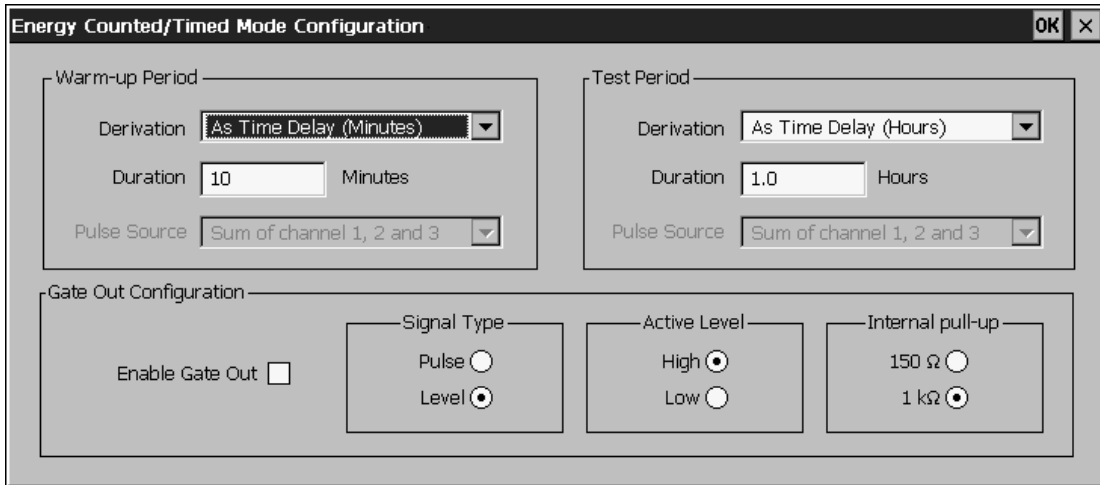

Figure 8-5. Counted/Timed Mode Configuration

If desired, a Gate Output signal may be enabled. This will be active for the duration of the actual measured test (not the warm-up and settling period). The gate signal can consist of a level of the required duration, or as a start and end pulse, and may be active high or low.

In the Counted/Timed mode the MUT and reference meter dials may advance more than the amount measured by the 6100A Energy option. This is normal and represents settling and warm-up times included in the test. The actual test duration and count to achieve the displayed result is accurate.

8-22. Gated mode

In Gated mode, the Energy Gate connector (on the rear panel) becomes an input. When the OPER key is pressed, power is applied to the MUT. Counting only takes place when the gate signal becomes 'active'. The test terminates and the 6100A output is turned off when the gate becomes inactive.

If the period between the first application of power to the MUT and the gate becoming active is greater than 2 seconds, the Gated mode accuracy is the same as for the Counted/Timed mode.

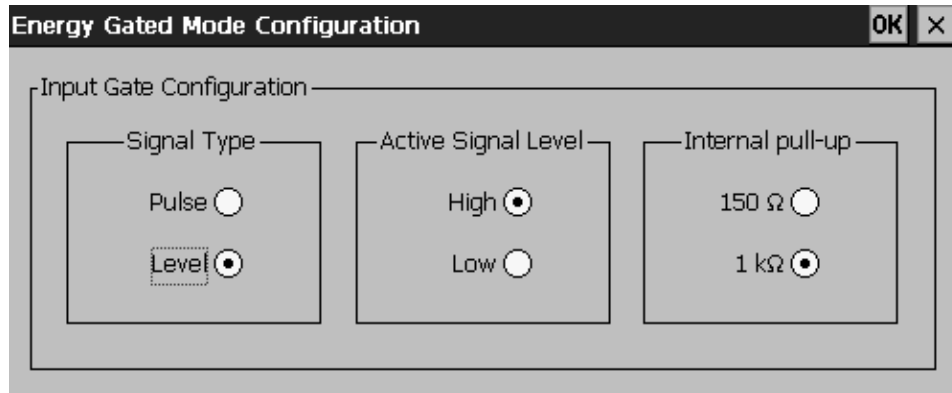

Figure 8-6. Gated Mode Configuration

In the Gated mode the MUT and reference meter dials may advance more than the amount measured by the 6100A Energy option. This is because the dial will advance in the period before the gate signal becomes active. The count displayed by the 6100A accurately reports the pulses received during the time the gate is active.

8-23. Packet mode

In Packet mode, the power from the main output terminals is timed to deliver the requested amount of energy. This has the advantage that the dial advance on the MUT will closely match the expected amount, unlike other modes which have settling times and warm-up periods.

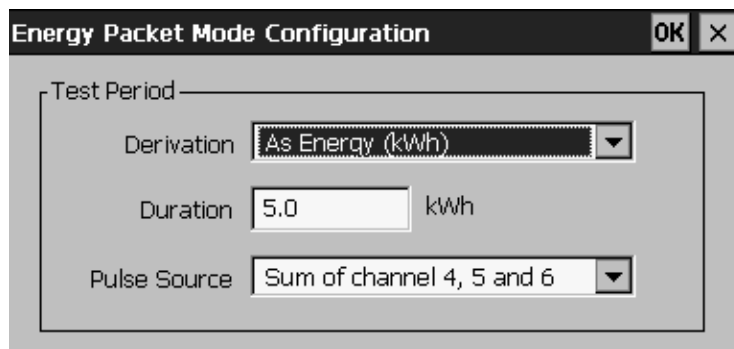

Figure 8-7. Packet Mode Configuration

In Packet mode, the effect of errors due to switching and settling time reduce as the test time increases.

8-24. Remote operation of the Energy option

Commands for the main 6100A unit are in chapter 5.

To start counting using the energy option, the energy option status panel must be displayed on the 6100A, if another wave-shape definition panel is shown, only the power outputs will be activated, not the energy counter/timer. To guarantee correct operation it is recommended that a command from the 'ENERgy' tree is the last one sent before ':OUTPut ON'; any command from this sub-system tree will re-display the energy status screen.

Note: Some commands must be sent in a specific order and this is indicated when applicable.

8-25. SCPI command set

The '[SOURce]:ENERgy' SCPI subsystem is used to remotely control the energy timer/counter hardware option. The SCPI status mechanism has also been expanded to support the energy option (see Figure 5-3 in chapter 5 and the STATus:OPERation treecommands and query commands at paragraph 8-50 to 8-53).

8-26. Operating mode

ENERgy:MODE(?) <cpd> { TCOUnt|PACKet|GATE|FRUN }

This command selects the operating mode for the energy counter/timer option.

On receiving an 'operate' request (':OUTPut ON'), the selected operating mode will count or time the pulse streams seen on the selected inputs.

- TCOUnt Counted/Timed mode.

The power outputs are activated, and allowed to stabilize. The selected energy pulse inputs are counted for a defined period. Then the outputs are automatically returned to standby when the completion criteria are met. This is the default mode of operation.

- PACKet Energy packet delivery mode.

The power outputs are activated for the time it takes the 6100A to deliver a specific 'packet' of energy and then deactivated again.

- GATE Gated input mode.

The power outputs are activated. An externally generated signal can then be used to gate the counting of the selected energy pulse inputs, and deactivate the power outputs.

- FRUN Free-run mode.

The free run mode is mainly provided for manual use but remote control can be used.

8-27. Energy units

ENERgy:UNIT(?) <cpd> { REAL|APParent|REACTive }

This command selects the base units used in energy counter/timer calculations.

- REAL Real power (Wh).
- APParent Apparent power (VAh).
- REACTive Reactive power (VARh).

8-28. Result presentation

ENERgy:PREsEntation(?) <cpd> { COUNTs|ENERgy }, <cpd> { PERRor|PREGistration }

This command configures the presentation of displayed results. It also defines the meaning the result fields returned by using the ':ENERgy:RESults?' command.

The first parameter defines the meaning of the MUT accumulated energy field:

- COUNTs As raw counts.
- ENERgy As accumulated energy (using the base units defined by the 'ENERgy:UNIT' command).

The second parameter defines the meaning of the measured error field:

- PERRor As percentage error = ((MUT counts - ref. counts) / ref. counts) * 100.0.
- PREGistration As percentage registration = (MUT counts / ref. counts) * 100.0.

8-29. Results

RESults? <cpd> { CH1|CH2|CH3|CH4|CH5|CH6 }

This query only command returns the result data for the selected channel:

- 1st <dnpd> Power or Frequency [1] (the power field's units are implied by the active 'ENERgy:UNITS' definition).
- 2nd <dnpd> MUT accumulated Energy or Counts [1].
- 3rd <dnpd> Reference accumulated Energy or Counts [1].
- 4th <dnpd> Percentage Error or Registration [2].

[1] Second meaning applies when 'PREsEntation' is set to 'COUNTs'.

[2] Second meaning applies when 'PREsEntation' is set to 'PREGistration'.

If the selected channel is inactive, a comma-delimited list of zero value <dnpd>s will be returned. A 'RESults?' query can be made at any time.

This command would typically be used in conjunction with the 'STATus:OPERation' commands, so data can be read a key stages in a test sequence.

The following conditions can be monitored using the 'STATus' system (see paragraph 8-49):

- Warm-up active.
- Test active.
- Input gate trigger pending.
- Energy timer/counter active.

8-30. Output gating

OGATE(?) <bool> { OFF|ON|0|1 }, <cpd> { PULSe|LEVel }, <cpd> { HIGH|LOW }, <cpd> { R150|R1000 }

This command configures the output gating signal. The OGATE settings have no effect when the operating mode is set to 'GATED'

The first parameter enables the generation of a gating signal. This is active while the power outputs are on.

The second parameter specifies the gating signal type:

- PULSe Indicate start/stop with pulse.
- LEVel Indicate start/stop with level change.

The third parameter specifies the gating signal level:

- HIGH Go to high level to indicate start/stop.
- LOW Go to low level to indicate start/stop.

The fourth parameter specifies which internal pull-up resistance value to use:

- R150 150 Ohm.
- R1000 1 k Ohm.

8-31. Input gating

IGATE(?) <cpd> { PULSe|LEVel }, <cpd> { HIGH|LOW }, <cpd> { R150|R1000 }

This command configures the input gating line. The settings only apply when the operating mode is set to 'GATED'.

The first parameter specifies the gating signal type:

- PULSe Indicate start/stop with pulse.
- LEVel Indicate start/stop with level change.

The second parameter specifies the gating signal level:

- HIGH Go to high level to indicate start/stop.
- LOW Go to low level to indicate start/stop.

The third parameter specifies which internal pull-up resistance value to use:

- R150 150 Ohm.
- R1000 1 k Ohm.

8-32. Warm-up sequence tree

The warm-up test sequence can be used to allow the MUT and reference sources to settle.

A warm-up sequence can be configured in any operating mode, but will only have an effect when the operating mode is 'TCOUnT'. The warm-up test sequence parameters specify the initial actions that will occur on sending 'OUTPut ON'. The test sequence will then be executed (see 8-35).

The source of pulses to count can be specified, as well as whether to count for a specific time period or counter value. The option to let the 6100 calculate the period (from energy) is also available.

It should also be noted (when 'TCOUnT' is selected) that there is always a settling period of approximately 1 Second, whether or not a warm-up period has been defined.

8-33. Warm-up duration**ENERgy:WUP:DURation(?)**{SEConds|COUNTs|WH},<dnpd>

This command specifies the duration of the warm-up sequence as either a time period, a counter value, or a period defined in terms of energy. When energy is used, the actual limits applied will be determined by the meter constant selected for the pulse source.

8-34. Warm-up pulse source**ENERgy:WUP:PSOURce(?)** {
CH1|CH2|CH3|CH4|CH5|CH6|MAIN|SUM123|SUM456|MEAN56|MEAN456 }

This command specifies the pulse source to use when determining the warm-up sequence completion criteria.

The actual sources available will be determined by the active MUT source and reference source selection.

Note: If one of the source parameters has been changed after using this command a valid default will be set (typically 'CH1' or 'MAIN'); so it is recommend that the 'MUT:WUP:PSOURce' command is sent AFTER any 'MUT:SOURce' or 'REfERENCE:SOURce' commands, to prevent unexpected side effects.

The source can be:

- CH1 to CH6 Raw pulse streams from individual channels.
- SUM123 Sum of channels 1 through 3.
- SUM456 Sum of channels 4 through 5.
- MEAN56 Arithmetic mean of channels 5 and 6.
- MEAN456 Arithmetic mean of channels 4 through 6.
- MAIN Equivalent pulse count of the power outputs (value calculated from the 'OUTPut:CONSTant' meter constant value and active power settings).

8-35. Test sequence tree

The test sequence commands specify the actions that will occur on sending 'OUTPut ON'. These parameters are applied in all operating modes except 'FRUN'.

The source of pulses to count can be specified, as well as whether to count for a specific time period or counter value. The option to let the 6100 calculate the period (from energy) is also available.

8-36. Test duration**ENERgy:TEST:DURation(?)**{ SEConds|COUNTs|WH }, <dnpd>

This command specifies the duration of the test sequence as either a time period, a counter value, or a period defined in terms of energy. When energy is used, the actual limits applied will be determined by the meter constant selected for the pulse source.

8-37. Test pulse source**ENERgy:TEST:PSOURce(?)** {
CH1|CH2|CH3|CH4|CH5|CH6|MAIN|SUM123|SUM456|MEAN56|MEAN456 }

This command specifies the pulse source to use when determining the test completion criteria.

The actual sources available will be determined by the active MUT source and reference source selection.

Note: If one of the source parameters has been changed after using this command a valid default will be set (typically 'MAIN'); so it is recommend that the 'MUT:TEST:PSOURce' command is sent after any 'MUT:SOURce' or 'REFerence:SOURce' commands, to prevent unexpected side effects.

The source can be:

- CH1 to CH6 Raw pulse streams from individual channels.
- SUM123 Sum of channels 1 through 3.
- SUM456 Sum of channels 4 through 5.
- MEAN56 Arithmetic mean of channels 5 and 6.
- MEAN456 Arithmetic mean of channels 4 through 6.
- MAIN Equivalent pulse count of the power outputs (value calculated from the 'OUTPut:CONSTant' meter constant value and active power settings).

8-38. **MUT tree**

The MUT commands configure a MUT source. A MUT source is typically made up from pulse streams from channels 1 to 3, though channels 4 to 6 can also be used when treated as independent sources (i.e. for 'drift monitoring').

8-39. **MUT meter constant**

ENERgy:MUT:CONSTant(?)

This command specifies the meter constant (as impulses per unit energy) used by channels considered to be MUT sources.

8-40. **MUT source**

**ENERgy:MUT:SOURce(?) {
CH1|CH1TO2|CH1TO3|CH1TO4|CH1TO5|CH1TO6|SUM123 }**

This command specifies the pulse source(s) used to define the MUT.

The source(s) can be:

- CH1, CH1TO2 to CH1TO6 Pulse streams from (independent) channels.
- SUM123 Sum of channels 1 through 3.

If the requested source channel is already in use as part of a reference source definition, the reference source definition will default to a value that does not clash with the MUT source (typically 'MAIN'). Because of this, it is recommended that the MUT source be defined before the reference source.

8-41. **MUT pull-up**

ENERgy:MUT:PULLup <cpd> { R150|R1000 }

This command specifies which internal pull-up resistance value to select for the reference source:

- R150 150 Ohm.
- R1000 1 k Ohm.

8-42. Reference tree

The Reference commands configure a reference source. The reference source can be made up from pulse streams on channels 4 to 6.

8-43. Reference meter constant

ENERgy:REFerence:CONSTant(?)

This command specifies the meter constant (as impulses per unit energy) used by channels considered to be reference sources.

8-44. Reference source

**ENERgy:REFerence:SOURce(?) {
 CH6|MAIN|SUM123|SUM456|MEAN56|MEAN456 }**

This command specifies the pulse source(s) used to define the reference source.

The source(s) can be:

- CH6 Pulse stream from (independent) channel 6.
- MEAN56 Arithmetic mean of channels 5 and 6.
- MEAN456 Arithmetic mean of channels 4 through 6.
- MAIN Equivalent pulse count of the power outputs (value calculated from the 'OUTPut:CONSTant' meter constant value and active power settings).
- MMUT Mean of the active MUT sources (typically used in 'drift monitor' scenarios).

Note: If the requested source channel is already in use as part of a MUT source definition, an error will be reported.

8-45. Reference pull-up

ENERgy:REFerence:PULLup <cpd> { R150|R1000 }

This command specifies which internal pull-up resistance value to select for the reference source:

- R150 150 Ohm.
- R1000 1 k Ohm.

8-46. Output tree

The output commands configure the pulse out channel. This channel generates a pulse stream that is proportional to the active power outputs.

Pulses will be generated whenever the energy timer/counter option has been selected, and the output is on.

8-47. Output meter constant

ENERgy:OUTPut:CONSTant(?)

This command specifies the meter constant (as impulses per unit energy) used by the output channel.

8-48. Output pull-up

ENERgy:OUTPut:PULLup[:STATe] <bool> { ON|OFF|0|1 }

This command specifies whether the output channel should switch in an internal pulled up resistor.

8-49. Status subsystem

This subsystem is used to enable bits in the Operation and Questionable Event registers. The Operation and Questionable: Event, Enable and Condition registers can be interrogated to determine their state.

The energy option makes use of the operational registers only.

8-50. Status operational Tree

The energy timer/counter can report its status through these commands.

8-51. Operation event

STATus: OPERational [:EVENT]?

This command returns the contents of the Operation Event register, clearing the register.

Bit	Condition Event	Comment
8	Warm-Up Active	Set '1' during the warm-up period. Set back to '0' when the period ends.
9	Test Active	Set '1' during the test period. Set back to '0' when the period ends.
10	Gate Trigger Pending	Set to '1' when waiting for the trigger. Set back to '0' when trigger is received.
11	Energy Active	Set '1' at the start of the Energy test. Set back to '0' at the end of the test.

8-52. Operational enable

STATus: OPERational: ENABLE(?) <dnpd>

This command sets the mask which enables those Operation Event register bits which are required to be summarized at bit 7 of the IEEE 488.2 Status Byte register.

Note: Only the energy timer/counter option effects these bits:

Bit	Enable Condition
8	Warm-Up Active.
9	Test Active.
10	Gate Trigger Pending.
11	Energy Active.

8-53. Operation condition

STATus: OPERational: CONDition?

This query only command returns the contents of the Operation Condition register, which is not cleared by the command.

Bit	Condition	Comment
8	Warm-Up Active	Set '1' during the warm-up period. Set back to '0' when the period ends.
9	Test Active	Set '1' during the test period. Set back to '0' when the period ends.
10	Gate Trigger Pending	Set to '1' when waiting for the trigger. Set back to '0' when trigger is received.
11	Energy Active	Set '1' at the start of the Energy test. Set back to '0' at the end of the test.

Note: This register contains transient states, in that its bits are not 'sticky', but are set and reset by the referred operations. The response to the query therefore represents an instantaneous 'Snapshot' of the Register State at the time that the query was accepted.

8-54. Energy Command Summary

Keyword	Parameter Form	Notes
[SOURce]:		
ENERgy:		
MODE(?)	<cpd>	{ TCOUnt PACKet GATE FRUN }
:WUP:DURation(?)	<cpd>, <dnpd>	{ SEConds COUNTs WH } Duration
:WUP:PSOURce(?)	<cpd>	{ CH1 CH2 CH3 CH4 CH5 CH6 MAIN SUM123 SUM456 MEAN456 MEAN56 }
:TEST:DURation(?)	<cpd>, <dnpd>	{ SEConds COUNTs ENERgy } Duration
:TEST:PSOURce(?)	<cpd>	{ CH1 CH2 CH3 CH4 CH5 CH6 MAIN SUM123 SUM456 MEAN456 MEAN56 }
:OGATe(?)	<bool>, <cpd>, <cpd>, <cpd>	{ OFF ON } { PULSe LEVel } { HIGH LOW } { R150 R1000 }
:IGATe(?)	<cpd>, <cpd>, <cpd>	{ PULSe LEVel } { HIGH LOW } { R150 R1000 }

Keyword	Parameter Form	Notes
:UNIT(?)	<cpd>	{ REAL APParent REACTive }
:MUT:SOURce(?)	<cpd>	{ CH1 SUM123 CH1TO2 CH1TO3 CH1TO4 CH1TO5 CH1TO6 }
:MUT:CONStant(?)	<dnpd>	in 'impulses per unit'
:MUT:PULLup(?)	<cpd>	{ R150 R1000 }
:REFerence:SOURce(?)	<cpd>	{ MAIN CH6 SUM456 MEAN456 MEAN56 MMUT }
:REFerence:CONStant(?)	<dnpd>	in 'impulses per unit'
:REFerence:PULLup(?)	<cpd>	{ R150 R1000 }
:Output:CONStant(?)	<dnpd>	in 'impulses per unit'
:Output:PULLup:{STATe}()	<bool>	{ OFF ON 0 1 }
RESults?	<cpd>	{ CH1 CH2 CH3 CH4 CH5 CH6 SUM123 }
		Response = <dnpd>, power or frequency. <dnpd>, MUT Energy or counts. <dnpd>, Ref. Energy or counts. <dnpd> % Error or % Registration.
		Note: Interpretation of above dependds on setting of ENERGY:PRESentation.
PRESentation(?)	<cpd>, <cpd>	{ COUNts ENERgy } , { PERRor PREGistration }

8-55. Action on receiving *RST

The following default settings are used on receiving a *RST command, on power cycling the last setting set will be used (all energy settings are non volatile).

Setting	Value following *RST
[:SOURce]	
:ENERgy	
:MODE(?)	Counted/Timedmode.
:UNIT(?)	Real (Wh).
:OGATe(?)	Output gate Off. Gate type level. Gate active low. Internal pull-up 1k Ohm.
:IGATe(?)	Gate type level. Gate active low. Internal pull-up 1k Ohm.

Setting	Value following *RST
:PRESentation(?)	Accumulated Energy, % Error.
:RESults(?)	n/a
:WUP	
:DURation(?)	Time delay, 100 Seconds.
:PSOURce(?)	Channel 1.
:TEST	
:DURation(?)	Time delay, 100 Seconds.
:PSOURce(?)	Channel 1.
:MUT	
:CONSTant(?)	1.0e5 i/Wh
:SOURce(?)	Channel 1.
:PULLup(?)	1 k Ohm.
:REFerence	
:CONSTant(?)	1.0e5 i/Wh
:SOURce(?)	Channel 1.
:PULLup(?)	1 k Ohm.
:OUTPut	
:CONSTant(?)	1.0e5 i/Wh

8-56. Calibration of the Energy option

The Energy option is not adjustable. The performance of the option depends on the accuracy of the internal crystal oscillator. This may be measured and verified in two ways:

8-57. *By direct measurement with a frequency meter:*

Equipment required: a frequency meter with accuracy 10ppm or better at the frequency to be measured.

Connect the frequency meter to the Energy Pulse Out connector.

Use the Channel Configuration options (paragraph 8-13) to set a meter constant for the Pulse Output that will result in a known output frequency for the total system power. The Use Internal Pull-up check box should be enabled (checked) for most frequency meters. For example, Enable and set the 6100A Voltage and Current to Sine 10V rms and 1A rms, phase angle zero, providing 10W rms of real power. Set the Output meter constant to 360,000 i/Wh, to give an output frequency of 1kHz.

Short Current Output terminals together, and ensure nothing is connected to the Voltage Output terminals. Select Free Run test mode, then press OPER.

Verify that the frequency meter reads the expected frequency $\pm(50\text{ppm} - \text{frequency meter accuracy in ppm})$.

Terminate the test by pressing STBY.

8-58. *Using an external reference frequency:*

Equipment required: a pulse source with frequency accuracy 10ppm or better.

Connect any Pulse Input channel to an accurate frequency reference source between 10Hz and 5MHz. The source must be suitable to drive the Pulse Inputs (see paragraph 8-7. for input driving specifications).

Enable a voltage channel. For safety reasons, ensure nothing is connected to the voltage terminals.

Use the Channel Configuration options (paragraph 8-13) to select MUT Source to be 'Channel 1 to 6 independent'.

Press Enter to accept the Channel Configuration and select the Display Units to be Counts.

Begin a Free Run test by pressing the OPER key.

Verify that the frequency displayed for the chosen Pulse Input channel is within $\pm(50\text{ppm} - \text{pulse source frequency accuracy in ppm})$ of the applied frequency.

Terminate the test by pressing STBY.

Appendices

Appendix	Title	Page
A	Glossary	A-1

Appendix A

Glossary

Introduction

Glossary of terms and abbreviations found in the 6100A manual or referenced documents.

Adjustment	The operation that aligns or modifies the calibrator output (or UUT indication) such that its error in relation to its published specification is minimized.
Calibration	Measurement of the calibrator (or UUT) against a defined and traceable standard using an established, documented and verifiable process with the object of determining the calibrator (or UUT) error. Implicit in this process is the ability to report the uncertainty of the measurement process in accordance with the ISO Guide to the Expression of Uncertainty in Measurement
Channel	Each output (voltage or current) is a channel. A voltage channel and a current channel together form a Phase
Dip	See Voltage Dip.
Distortion	In a waveform, any steady state deviation from the demanded shape.
EUT	Equipment Under Test
First harmonic	The first harmonic of a waveform is its fundamental frequency. Note that for the 6100A, the 1 st harmonic of a waveform may have zero amplitude.
Flicker	Repetitive (voltage) level variation in the range to cause the physiological phenomenon of flicker.

Fluctuation	A change in the amplitude of a waveform which does not alter the harmonic content or phase relationships within the waveform
Harmonics	Multiples of the fundamental supply frequency
IEC 61868	Evaluation of Flicker severity
IEC 61000-3-2	Limits for harmonic current emissions (equipment input current \leq 16A per phase)
IEC 61000-3-3	Limits of voltage changes, voltage fluctuations and flicker in public low-voltage supply systems (for equipment \leq 16A per phase)
IEC 61000-4-7	Harmonics and interharmonics measurements
IEC 61000-4-11	Voltage dips, short interruptions and voltage variations
IEC 61000-4-14	Voltage fluctuation immunity test
IEC 61000-4-15	Flicker meter functional design specification
IEC 61000-4-30 (draft)	
Interharmonic	A frequency component of a periodic quantity (ac waveform) that is not an integer multiple of the frequency at which the system is operating.
Interruption	For a single-phase voltage, there is an interruption if the RMS(1/2) value is below 10% of the reference voltage. In a three-phase system, an interruption is when all three phases are below 10% simultaneously.
Measurement uncertainty	Where used in this document, Measurement Uncertainty is the contribution to uncertainty because of resolution of the measuring device and the randomness of the indication due to 'noise'.
MUT	Meter Under Test (used in the Energy option chapter).
Nominal voltage	The nominal voltage is the reference voltage.
Phase	A phase is the combination of a voltage channel and a current channel. The phases are identified as L1, L2 and L3. L1 is the master phase in a multi-phase system. Neutral phase is identified as N.
Phase angle	Phase angle is the angular difference between two corresponding points on two ac waveforms of the same frequency or which have frequencies which are integer multiples of each other.
Pst	Short term flicker indicator, Pst = 1 is the conventional threshold of irritability.
Reference channel	The reference channel is L1, Voltage
Reference voltage	The reference voltage is the voltage that is used for determining the depth of a dip and the height

	of a swell.
RMS voltage shape	The time function of the RMS voltage change evaluated as a single value for each successive half period between zero-crossings of the source voltage.
RMS(1/2)	Actual instantaneous RMS voltage: the sliding value of the RMS voltage measured over an exact period and refreshed each half period.
Sag	See Voltage Dip.
Short interruption	The disappearance of the supply voltage for a period of time typically not exceeding 1 minute.
Swell	see Voltage swell
THD	Total Harmonic Distortion
Total harmonic current	Total RMS value of the harmonic current components.
Voltage dip	A sudden reduction of the voltage at a point in the electrical system, followed by voltage recovery after a short period of time, from half a cycle to a few seconds.
Voltage fluctuation	Series of changes of RMS voltage evaluated as a single value for each successive half-period between zero-crossings of the source voltage.
Voltage swell	A sudden increase of the voltage at a point in the electrical system, followed by voltage recovery after a short period of time, from half a cycle to a few seconds.

